

Database Management System
(CS403)

DATABASE MANAGEMENT SYSTEM	1
LECTURE NO. 01	9
Reading Material	9
Overview of Lecture	9
Introduction to the course	9
Database definitions:	10
Importance of the Databases	12
Databases and Traditional File Processing Systems	12
Advantages of Databases	15
LECTURE NO. 02	17
Reading Material	17
Overview of Lecture	17
Difference between Data and Information	17
Further Advantages of Database Systems:	19
Cost Involved:	21
Importance of Data	22
Levels of Data	22
Users of Database Systems:	24
LECTURE NO. 03	31
Reading Material	31
Overview of Lecture	31
Database Architecture:	31
The Architecture:	33
External View (Level, Schema or Model):	35
Conceptual or Logical View:	37
LECTURE NO. 04	40
Reading Material	40
Overview of Lecture	40
Internal or Physical View / Schema	40
Data Independence:	43
Functions of DBMS	45
LECTURE NO. 05	50
Reading Material	50
Overview of Lecture	50
Database Development Process	51
Preliminary Study:	51
Database Development Process: Approach 2	54
Tools Used for Database System Development:	56
Data Flow Diagrams:	56
Types of DFD	60
LECTURE NO. 06	63
Reading Material	63
Overview of Lecture	63
Detailed Data Flow Diagram:	63
Data Dictionary	64
Database Design Phase	67

Data Model	68
Types of Data Models.....	68
Types of Database Design	69
LECTURE NO. 07	70
Reading Material.....	70
Overview of Lecture	70
Entity-Relationship Data Model	70
The Entity.....	71
Classification of entity types	74
Attribute	75
Types of Attributes.....	77
Summary:	79
Exercises:	79
LECTURE NO. 08	80
Reading Material.....	80
Overview of Lecture	80
Attributes.....	80
The Keys.....	80
LECTURE NO. 09	85
Reading Material.....	85
Overview of Lecture	85
Relationships	85
Types of Relationships	87
LECTURE NO. 10	91
Reading Material.....	91
Overview of Lecture	91
Roles in Relationships	95
Dependencies.....	97
Enhancements in E-R Data Model:	98
Super-type and Subtypes	98
Summary:	99
LECTURE NO. 11	100
Reading Material.....	100
Overview of Lecture	100
Inheritance Is	100
Super types and Subtypes	101
Specifying Constraints.....	103
Completeness Constraint.....	103
Disjointness Constraint.....	104
Subtype Discriminator	108
LECTURE NO. 12	110
Reading Material.....	110
Overview of Lecture	110
Steps in the Study of system	110
LECTURE NO. 13	118
Reading Material.....	118
Overview of Lecture	118

Identification of Entity Types of the Examination System	118
Relationships and Cardinalities in between Entities.....	120
Conceptual Database Design.....	122
Logical Database Design.....	122
Conclusion	123
LECTURE NO. 14	124
Reading Material.....	124
Overview of Lecture	124
Relational Data Model	125
Introduction to the Relational Data model	126
Mathematical Relations	129
Database Relations	130
Summary	130
Exercise:.....	131
LECTURE NO. 15	132
Reading Material.....	132
Overview of Lecture	132
Database and Math Relations	132
Degree of a Relation.....	133
LECTURE NO. 16	140
Reading Material.....	140
Overview of Lecture:	140
Mapping Relationships	140
Binary Relationships.....	140
Unary Relationship	144
Data Manipulation Languages.....	146
Relational Algebra	147
Exercise:.....	147
LECTURE NO. 17	148
Reading Material.....	148
Overview of Lecture:	148
The Project Operator	150
LECTURE NO. 18	157
Reading Material.....	157
Overview of Lecture:	157
Types of Joins.....	157
Theta Join:	157
Equi-Join:	159
Natural Join:.....	159
Outer Join:	161
Semi Join:	161
Relational Calculus.....	162
Tuple Oriented Relational Calculus:.....	162
Domain Oriented Relational Calculus:	162
Normalization.....	162
LECTURE NO. 19	164
Reading Material.....	164
Overview of Lecture:	164

Functional Dependency.....	164
Inference Rules	166
Normal Forms.....	166
Summary	167
Exercise:.....	168
LECTURE NO. 20	169
Reading Material.....	169
Overview of Lecture:	169
Second Normal Form	169
Third Normal Form	171
Boyce - Codd Normal Form.....	173
Higher Normal Forms	175
Summary	175
Exercise:.....	175
LECTURE NO. 21	176
Reading Material.....	176
Overview of Lecture:	176
Normalization Summary	176
Normalization Example.....	177
Physical Database Design.....	181
Summary	182
LECTURE NO. 22	183
Overview of Lecture	183
The Physical Database Design Considerations and Implementation	183
DESIGNING FIELDS.....	184
CODING AND COMPRESSION TECHNIQUES:.....	185
LECTURE NO. 23	187
Reading Material.....	187
Overview of Lecture	187
Physical Record and De-normalization	187
Partitioning.....	187
Physical Record and Denormalization	187
Denormalization Situation 1:.....	188
Partitioning.....	189
LECTURE NO. 24	191
Reading Material.....	191
Overview of Lecture	191
Vertical Partitioning.....	191
Replication	192
Reduced training cost.....	194
MS SQL Server	194
LECTURE NO. 25	196
Reading Material.....	196
Overview of Lecture	196
Rules of SQL Format.....	196
Data Types in SQL Server.....	197
Summary:	200
Exercise:.....	200

LECTURE NO. 26	201
Reading Material	201
Overview of Lecture	201
Categories of SQL Commands	201
Summary	205
Exercise:	205
LECTURE NO. 27	206
Reading Material	206
Overview of Lecture	206
Alter Table Statement	206
LECTURE NO. 28	210
Reading Material	210
Select Statement	211
Attribute Alias	213
LECTURE NO. 29	215
Reading Material	215
Overview of Lecture	215
Data Manipulation Language	215
LECTURE NO. 30	220
Reading Material	220
Overview of Lecture	220
ORDER BY Clause	220
Functions in SQL	221
GROUP BY Clause	222
HAVING Clause	223
Cartesian Product	224
Summary	225
LECTURE NO. 31	226
Reading Material	226
Overview of Lecture	226
Inner Join	226
Outer Join	228
Semi Join	230
Self Join	231
Subquery	232
Summary	236
Exercise:	237
LECTURE NO. 32	238
Reading Material	238
Overview of Lecture	238
Application Programs	238
User Interface	239
Forms	240
Tips for User Friendly Interface	243
LECTURE NO. 33	246
Reading Material	246
Overview of Lecture	246

LECTURE NO. 34	255
Reading Material	255
Overview of Lecture	255
LECTURE NO. 35	260
Reading Material	260
Overview of Lecture	260
File Organizations	260
LECTURE NO. 36	265
Reading Material	265
Overview of Lecture	265
Hashing	265
Hash Functions	266
Hashed Access Characteristics	266
Mapping functions	266
Open addressing:	269
LECTURE NO. 37	270
Reading Material	270
Overview of Lecture:	270
Index	270
Index Classification	272
Summary	274
LECTURE NO. 38	275
Reading Material	275
Overview of Lecture	275
Ordered Indices	275
Clustered Indexes	275
Non-clustered Indexes	276
Dense and Sparse Indices	276
Multi-Level Indices	277
LECTURE NO. 39 AND 40	280
Reading Material	280
Overview of Lecture	280
Views	280
To Focus on Specific Data	280
Characteristics /Types of Views:	283
Characteristics of Views	286
LECTURE NO. 41	288
Reading Material	288
Overview of Lecture	288
Updating Multiple Tables	288
Materialized Views	289
Transaction Management	291
LECTURE NO. 42	293
Reading Material	293
Overview of Lecture	293
The Concept of a Transaction	293
Transactions and Schedules	294

Concurrent Execution of Transactions	295
Serializability.....	296
Lock-Based Concurrency Control.....	297
Deadlocks	299
LECTURE NO. 43	302
Reading Material.....	302
Overview of Lecture	302
Incremental Log with Deferred Updates	302
Incremental Log with Immediate Updates	305
Concurrency Control.....	307
Summary	308
LECTURE NO. 44	310
Reading Material.....	310
Overview of Lecture	310
Uncommitted Update Problem	310
Inconsistent Analysis	311
Serial Execution.....	312
Serializability.....	315
Locking	315
Summary	316
LECTURE NO. 45	318
Reading Material.....	318
Overview of Lecture:	318
Locking Idea	319
DeadLock.....	320
DeadLock Handling	320
Wait – for Graph:	320
Deadlock Resolution.....	323
Timestamping rules	324

Lecture No. 01

Reading Material

“Database Systems Principles, Design and Implementation” written by Catherine Ricardo, Maxwell Macmillan.	Chapter 1.
--------------------------------------------------------------------------------------------------------------	------------

Overview of Lecture

- Introduction to the course
- Database definitions
- Importance of databases
- Introduction to File Processing Systems
- Advantages of the Database Approach

Introduction to the course

This course is first (fundamental) course on database management systems. The course discusses different topics of the databases. We will be covering both the theoretical and practical aspects of databases. As a student to have a better understanding of the subject, it is very necessary that you concentrate on the concepts discussed in the course.

Areas to be covered in this Course:

- **Database design and application development:** How do we represent a real-world system in the form of a database? This is one major topic covered in this course. It comprises of different stages, we will discuss all these stages one by one.
- **Concurrency and robustness:** How does a DBMS allow many users to access data concurrently, and how does it protect against failures?
- **Efficiency and Scalability:** How does the database cope with large amounts of data?

- **Study of tools to manipulate databases:** In order to practically implement, that is, to perform different operations on databases some tools are required. The operations on databases include right from creating them to add, remove and modify data in the database and to access by different ways. The tools that we will be studying are a manipulation language (SQL) and a DBMS (SQL Server).

Database definitions:

Definitions are important, especially in technical subjects because definition describes very comprehensively the purpose and the core idea behind the thing. Databases have been defined differently in literature. We are discussing different definitions here, if we concentrate on these definitions, we find that they support each other and as a result of the understanding of these definitions, we establish a better understanding of use, working and to some extent the components of a database.

Def 1: A shared collection of logically related data, designed to meet the information needs of multiple users in an organization. The term database is often erroneously referred to as a synonym for a “database management system (DBMS)”. They are not equivalent and it will be explained in the next section.

Def 2: A collection of data: part numbers, product codes, customer information, etc. It usually refers to data organized and stored on a computer that can be searched and retrieved by a computer program.

Def 3: A data structure that stores metadata, i.e. data about data. More generally we can say an organized collection of information.

Def 4: A collection of information organized and presented to serve a specific purpose. (A telephone book is a common database.) A computerized database is an updated, organized file of machine readable information that is rapidly searched and retrieved by computer.

Def 5: An organized collection of information in computerized format.

Def 6: A collection of related information about a subject organized in a useful manner that provides a base or foundation for procedures such as retrieving information, drawing conclusions, and making decisions.

Def 7: A Computerized representation of any organizations flow of information and storage of data.

Each of the above given definition is correct, and describe database from slightly variant perspectives. From exam point of view, anyone will do. However, within this course, we will be referring first of the above definitions more frequently, and concepts discussed in the definition like, logically related data, shared collection should be clear. Another

important thing that you should be very clear about is the difference between database and the database management system (DBMS). See, the database is the collection of data about anything, could be anything. Like cricket teams, students, busses, movies, personalities, stars, seas, buildings, furniture, lab equipment, hobbies, hotels, pets, countries, and many more anything about which you want to store data. What we mean by data; simply the facts or figures. Following table shows the things and the data that we may want to store about them:

Thing	Data (Facts or figures)
Cricket Player	Country, name, date of birth, specialty, matches played, runs etc.
Scholars	Name, date of birth, age, country, field, books published etc.
Movies	Name, director, language (Punjabi is default in case of Pakistan) etc.
Food	Name, ingredients, taste, preferred time, origin, etc.
Vehicle	Registration number, make, owner, type, price, etc.

There could be infinite examples, and please note that the data that is listed about different things in the above table is not the only data that can be defined or stored about these things. As has been explained in the definition one above, there could be so many facts about each thing that we are storing data about; what exactly we will store depends on the perspective of the person or organization who wants to store the data. For example, if you consider food, data required to be stored about the food from the perspective of a cook is different from that of a person eating it. Think of a food, like, Karhahi Ghosht, the facts about Karhahi ghosht that a cook will like to store may be, quantity of salt, green and red chilies, garlic, water, time required to cook and like that. Where as the customer is interested in chicken or meat, then black or red chilies, then weight, then price and like that. Well, definitely there are some things common but some are different as well. The thing is that the perspective or point of view creates the difference in what we store; however, the main thing is that the database stores the data.

The database management system (DBMS), on the other hand is the software or tool that is used to manage the database and its users. A DBMS consist of different components or subsystem that we will study about later. Each subsystem or component of the DBMS performs different function(s), so a DBMS is collection of different programs but they all work jointly to manage the data stored in the database and its users. In many books and may be in this course sometimes database and database management system are used interchangeably but there is a clear difference and we should be clear about them. Sometimes another term is used, that is, the database system, again, this term has been used differently by different people, however in this course we use the term database system as a combination of database and the database management system. So database is collection of data, DBMS is tool to manage this data, and both jointly are called database system.

Importance of the Databases

Databases are important; why? Traditionally computer applications are divided into commercial and scientific (or engineering) ones. Scientific applications involve more computations, that is, different type of calculations that vary from simple to very complex. Today such applications exist, like in the fields of space, nuclear, medicine that take hours or days of computations on even computers of the modern age. On the other hand, the applications that are termed as commercial or business applications do not involve much computations, rather minor computation but mainly they perform the input/output operations. That is, these applications mainly store the data in the computer storage, then access and present it to the users in different formats (also termed as data processing) for example, banks, shopping, production, utilities billing, customer services and many others. As is clear from the example systems mentioned, the commercial applications exist in the day to day life and are related directly with the lives of common people. In order to manage the commercial applications more efficiently databases are the ultimate choice because efficient management of data is the sole objective of the databases. So such applications are being managed by databases even in a developing country like Pakistan, yet to talk about the developed countries. This way databases are related directly or indirectly almost every person in society.

Databases are not only being used in the commercial applications rather today many of the scientific/engineering application are also using databases less or more. Databases are concerned of effectively latter form of applications which are more Commercial applications. The goal of this course is to present an in-depth introduction to databases, with an emphasis on how to organize information in the database and to maintain it and retrieve it efficiently, that is, how to design a database and use it effectively.

Databases and Traditional File Processing Systems

Traditional file processing system or simple file processing system refers to the first computer-based approach of handling the commercial or business applications. That is why it is also called a replacement of the manual file system. Before the use computers, the data in the offices or business was maintained in the files (well in that perspective some offices may still be considered in the pre-computer age). Obviously, it was laborious, time consuming, inefficient, especially in case of large organizations. Computers, initially designed for the engineering purposes were thought of as blessing, since they helped efficient management but file processing environment simply transformed manual file work to computers. So processing became very fast and efficient, but as file processing systems were used, their problems were also realized and some of them were very severe as discussed later.

It is not necessary that we understand the working of the file processing environment for the understanding of the database and its working. However, a comparison between the characteristics of the two definitely helps to understand the advantages of the databases

and their working approach. That is why the characteristics of the traditional file processing system environment have been discussed briefly here.

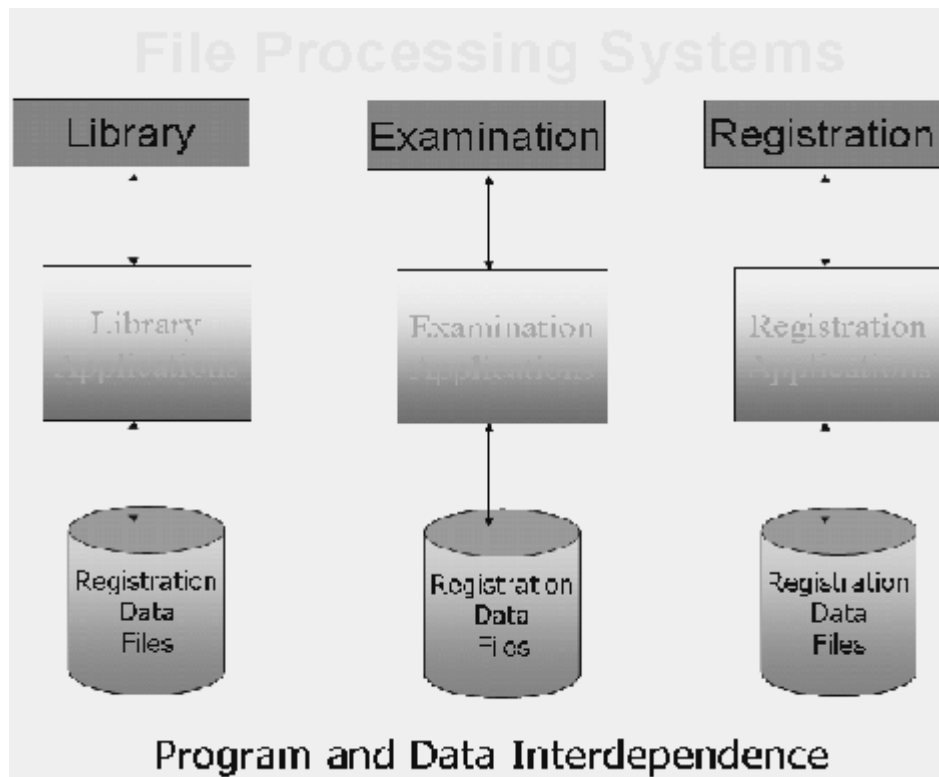

Fig. 1: A typical file processing environment

The diagram presents a typical traditional file processing environment. The main point being highlighted is the **program and data interdependence**, that is, program and data depend on each other, well they depend too much on each other. As a result any change in one affects the other as well. This is something that makes a change very painful or problematic for the designers or developers of the system. What do we mean by change and why do we need to change the system at all. These things are explained in the following.

The systems (even the file processing systems) are created after a very detailed analysis of the requirements of the organizations. But it is not possible to develop a system that does not need a change afterwards. There could be many reasons, mainly being that the users get the real taste of the system when it is established. That is, users tell the analysts or designers their requirements, the designers design and later develop the system based on those requirements, but when system is developed and presented to the users, it is only then they realize the outcome of the effort. Now it could be slightly and (unfortunately) sometimes very different from what they expected or wanted it to be. So the users ask changes, minor or major. Another reason for the change is the change in the requirements. For example, previously the billing was performed in an organization on the monthly

basis, now company has decided to bill the customers after every ten days. Since the bills are being generated from the computer (using file processing system), this change has to be incorporated in the system. Yet another example is that, initially bills did not contain the address of the customer, now the company wants the address to be placed on the bill, so here is change. There could be many more examples, and it is so common that we can say that almost all systems need changes, so system development is always an on-going process.

So we need changes in the system, but due to program-data interdependence these changes in the systems were very hard to make. A change in one will affect the other whether related or not. For example, suppose data about the customer bills is stored in the file, and different programs use this file for different purposes, like adding data into the bills file, to compute the bill and to print the bill. Now the company asks to add the customers' address in the bills, for this we have to change the structure of the bill file and also the program that prints the bill. Well, this was necessary, but the painful thing is that the other programs that are using these bills files but are not concerned with the printing of the bills or the change in the bill will also have to be changed, well; this is needless and causes extra, unnecessary effort.

Another major drawback in the traditional file system environment is the non-sharing of data. It means if different systems of an organization are using some common data then rather than storing it once and sharing it, each system stores data in separate files. This creates the problem of redundancy or wastage of storage and on the other hand the problem on inconsistency. The change in the data in one system sometimes is not reflected in the same data stored in other system. So different systems in organization; store different facts about same thing. This is inconsistency as is shown in figure below.

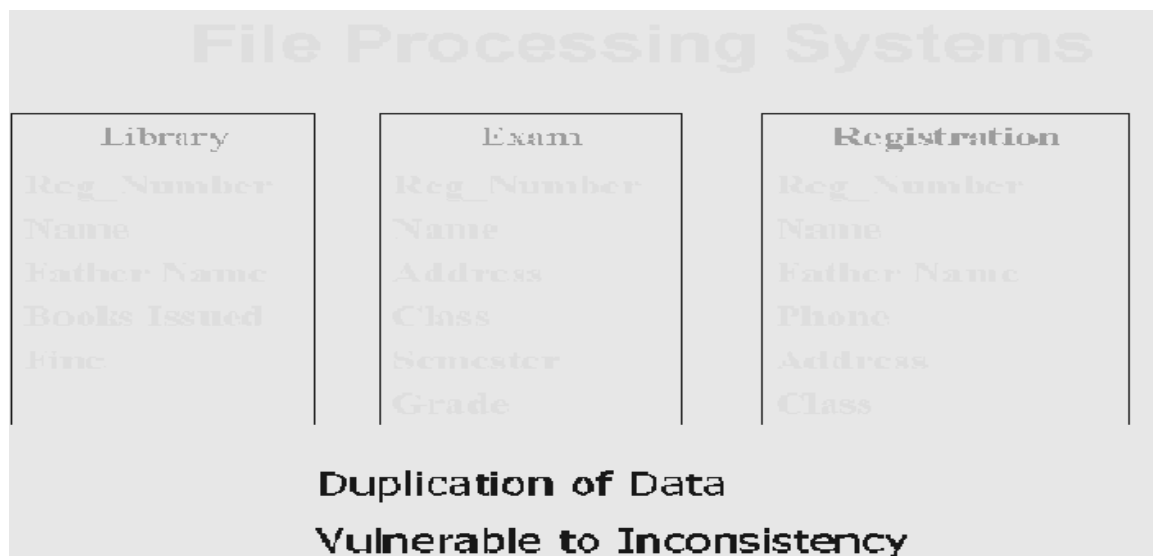

Fig. 2: Some more problems in File System Environment

Previous section highlighted the file processing system environment and major problems found there. The following section presents the benefits of the database systems.

Advantages of Databases

It will be helpful to reiterate our database definition here, that is, database is a shared collection of logically related data, designed to meet the information needs of multiple users in an organization. A typical database system environment is shown in the figure 3 below:

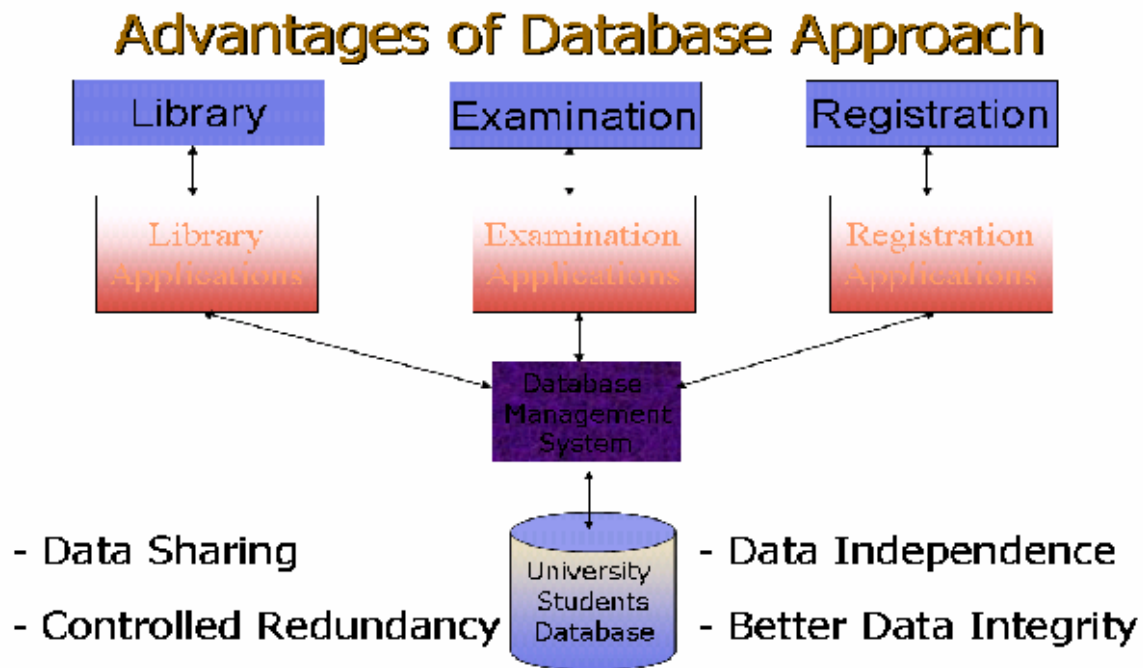

Fig. 3: A typical Database System environment

The figure shows different subsystem or applications in an educational institution, like library system, examination system, and registration system. There are separate, different application programs for every application or subsystem. However, the data for all applications is stored at the same place in the database and all application programs, relevant data and users are being managed by the DBMS. This is a typical database system environment and it introduces the following advantages:

- **Data Sharing**

The data for different applications or subsystems is placed at the same place. This introduces the major benefit of data sharing. That is, data that is common among different applications need not to be stored repeatedly, as was the case in the file processing environment. For example, all three systems of an educational institution shown in figure 3 need to store the data about students. The example data can be seen

from figure 2. Now the data like registration number, name, address, father name that is common among different applications is being stored repeatedly in the file processing system environment, where as it is being stored just once in database system environment and is being shared by all applications. The interesting thing is that the individual applications do not know that the data is being shared and they do not need to. Each application gets the impression as if the data is being for stored for it. This brings the advantage of saving the storage along with others discussed later.

- **Data Independence**

Data and programs are independent of each other, so change in one has no or minimum effect on other. Data and its structure is stored in the database where as application programs manipulating this data are stored separately, the change in one does not unnecessarily effect other.

- **Controlled Redundancy**

Means that we do not need to duplicate data unnecessarily; we do duplicate data in the databases, however, this duplication is deliberate and controlled.

- **Better Data Integrity**

Very important feature; means the validity of the data being entered in the database. Since the data is being placed at a central place and being managed by the DBMS, so it provides a very conducive to check or ensure that the data being entered into the database is actually valid. Integrity of data is very important, since all the processing and the information produced in return are based on the data. Now if the data entered is not valid, how can we be sure that the processing in the database is correct and the results or the information produced is valid? The businesses make decisions on the basis of information produced from the database and the wrong information leads to wrong decisions, and business collapse. In the database system environment, DBMS provides many features to ensure the data integrity, hence provides more reliable data processing environment.

Dear students, that is all for this lecture. Today we got the introduction of the course, importance of the databases. Then we saw different definitions of database and studied what is data processing then studied different features of the traditional file processing environment and database (DB) system environment. At the end of lecture we were discussing the advantages of the DB approach. There some others to be studied in the next lecture. Suggestions are welcome.

Exercises

- Think about the data that you may want to store about different things around you
- List the changes that may arise during the working of any system, lets say Railway Reservation System

Lecture No. 02

Reading Material

“Database Systems Principles, Design and Implementation”
written by Catherine Ricardo, Maxwell Macmillan.

Overview of Lecture

- Some Additional Advantages of Database Systems
- Costs involved in Database systems
- Levels of data
- Database users

Difference between Data and Information

Data is the collection of raw facts collected from any specific environment for a specific purpose. Data in itself does not show anything about its environment, so to get desired types of results from the data we transform it into information by applying certain processing on it. Once we have processed data using different methods data is converted into meaningful form and that form of the Data is called information

Example:

Example:

Company: Super Soft		Dept: Sales	
Emp Name	Age	Salary	
Malik Sharif	23	55	
Sh. M. Akmal	24	55	
M. A. Butt	20	40	
Malik Junaid	19	20	

Fig. 1: Data and Information

If we consider the data in the above figure without the titles or the labels associated with the data (EmpName, age, salary) then it is not much useful. However, after attaching these labels it brings some meanings to us, this meaningfulness is further increased when we associate some other labels, like the company name and the department name etc. So this is a very simple example of processing that we can do on the data to make it information.

Once we have clear idea of what data and information is we proceed with another term known as “schema” Schema is a repository or structure to express the format and other different information about data and database, as we can see from the database definition “Database is a self describing collection of interrelated records.” The word self describing means that the data storage and retrieval mechanism and its format is described in the database, Actual place where these definitions and descriptions are performed is database schema.

○ **Database Application:**

Database Application is a program or group of programs which is used for performing certain operations on the data stored in the database. These operations may contain insertion of data into a database or extracting some data from the database based on a certain condition, updating data in the database, producing the data as output on any device such as Screen, disk or printer.

○ **Database Management Systems:**

Database management system is software of collection of small programs to perform certain operation on data and manage the data.

Two basic operations performed by the DBMS are:

- Management of Data in the Database
- Management of Users associated with the database.

Management of the data means to specify that how data will be stored, structured and accessed in the database.

Management of database users means to manage the users in such a way that they can perform any desired operations on the database. DBMS also ensures that a user can not perform any operation for which he is not allowed. And also an authorized user is not allowed to perform any action which is restricted to that user.

In General DBMS is a collection of Programs performing all necessary actions associated to a database.

Further Advantages of Database Systems:

Database systems are very much beneficent to enterprises and businesses, some of the advantages are listed below:

- Data consistency
- Better data security
- Faster development of new applications
- Economy of scale
- Better concurrency control
- Better backup and recovery procedures

- **Data Consistency:**

Data consistency means that the changes made to different occurrence of data should be controlled and managed in such a way that all the occurrences have same value for any specific data item. Data inconsistency leads to a number of problems, including loss of information and incorrect results. In database approach it is controlled because data is shared and consistency is controlled and maintained.

- **Better Data Security:**

All application programs access data through DBMS, So DBMS can very efficiently check that which user is performing which action and accessing which part of data , So A DBMS is the most effectively control and maintain security of Data stored in a database.

- **Faster Application Development:**

The database environment allows us faster application development because of its many reasons. As we know that database is designed with the factor of future development in mind

So whenever we have to build a new application to meet the growing needs of the computerized environment, it may be easy due to the following reason:

- The data needed for the new application already resides in the database.

- The data might not already reside in the database but it could be derived from the data present in the database

Thus we can say that, to develop a new application for an existing database system less effort is required in terms of the system and database design.

○ **Economy of Scale:**

Databases and database systems are designed to share data stored in one location for many different purposes, So it needs not be stored as many number of times in different forms as it is used, for example the data used by Admission Department of any education institution can be used to maintain the attendance record of the students as well as the examination records of the students. So it saves us lots of efforts and finances providing economy of scale.

○ **Better Concurrency Control:**

Concurrency means the access of database form as number of points simultaneously. Concurrency control means to access the database in such a way that all the data accesses are completed correctly and transparently. One example of controlled concurrency is the use of ATM Machine for withdrawal of money (cash). All ATM machines of a bank are interconnected to a central database system worldwide, so that a user can access its account from anywhere in the world and can get cash from any ATM terminal. As there are thousands of ATM terminal across the world for a specific bank so as a result thousands of user process and access the bank's database. All this process is managed concurrently using the database systems and is done in such an efficient manner that no two user face any delay in the processing of their requests.

○ **Better Backup and Recovery Facility:**

Data is a very important resource and is very much valuable for any organization, loss of such a valuable resource can result in a huge strategic disasters. As Data is stored on today's' storage devices like hard disks etc., It is necessary to take periodic backups of data so that in case a storage device loses the data due to any damage we should be able

to restore the data a nearest point, Database systems offer excellent facilities for taking backup of data and good mechanism of restoring those backups to get back the backed-up data.

It some time happens that a database which was in use and very important transactions were made after the last backup was made, all of a sudden due to any disastrous situation the database crashes (improper shutdown, invalid disk access, etc.) Now in such a situation the database management system should be able to recover the database to a consistent state so that the transactions made after the last backup are not lost.

Cost Involved:

Enjoying all these benefits of the database systems do have some additional costs on any organization which is going to adopt a database environment. These charges may also be known as the disadvantages of the database system. Different types of costs (Financial and Personnel) which an organization faces in adopting a database system are listed below:

- **High Cost:**

Database Systems have a number of inherent charges which are to be born by any organization that is going to adopt it. High Cost is one of these inherent charges, it includes the need for specialized software which is used to run database systems, Additional and specialized hardware and technically qualified staff are the requirements for adopting to the database system, all these requirements need an organization to invest handsome amount of money to have all the requirements of the database systems.

- **Conversion Cost:**

Once an organization has decided to adopt database system for its operations, it is not only the finance and technical man-power which is required for switching on to database system, it further has some conversion charges needed for adopting the database system, this is also a very important stage for making decision about the way the system will be converted to database system.

- **Difficult Recovery Procedures:**

Although the database systems and database management systems provide very efficient ways of data recovery in case of any disaster, still the process of recovering a crashed database is very much technical and needs good professional skills to perform a perfect recovery of the database.

Importance of Data

- **Data as a Resource:**

A resource is anything which is valuable for an organization. There can be a number of resources in any organization, for example, Buildings, Furniture, Vehicle, Technical Staff, Managers, supporting staff and Machinery etc. As all these are resources for organizations and are consumed very much carefully to get full benefit out of them. Data in the same way is a very important resource and needs to be considered equally important as other resources are considered.

Why we call data as a resource?

Data is truly considered a resource because for an organization to make proper decisions at proper time it is only the data which can provide correct information and in-turn cause good utilization of other organizational resources. Organizations can not make good and effective decisions if the required data is not available in time or in the correct and desired format, such bad and miscalculated decisions ultimately lead to the failure of organizations or business.

Levels of Data

- **Real World Data**

The real world level of data means that level of data at which entities or objects exist in reality, it means that any object existing in reality has a name and other identifiable attributes through which we can identify that specific object or entity.

Example:

Any Student

○ **Meta Data:**

For storage of the data related to any entity or object existing at real world level we define the way the data will be stored in the database. This is called Meta data. Meta data is also known as schema for the real world data. It tells that what type of data will be stored in the database, what will be size of a certain attribute of the real world data, how many and what attributes will be used to store the data about the entity in the database.

Example: Name ,Character Type, 25 character size field,
 Age, Date type, 8 bytes size
 Class, Alpha Numeric, 8 byte size field

○ **Existence of Data:**

Existence of the data level shows the actual data regarding the entities as real world level according to the rules define at the Meta Data level.

Example:

According to the definition given in the Meta data level the Actual data or Data occurrence for the entity at real world level is shown below:

Name	Age	Class	
Ali	20/8/1979	MCS-I	
Amir	22/3/1978	MCS-II	etc...

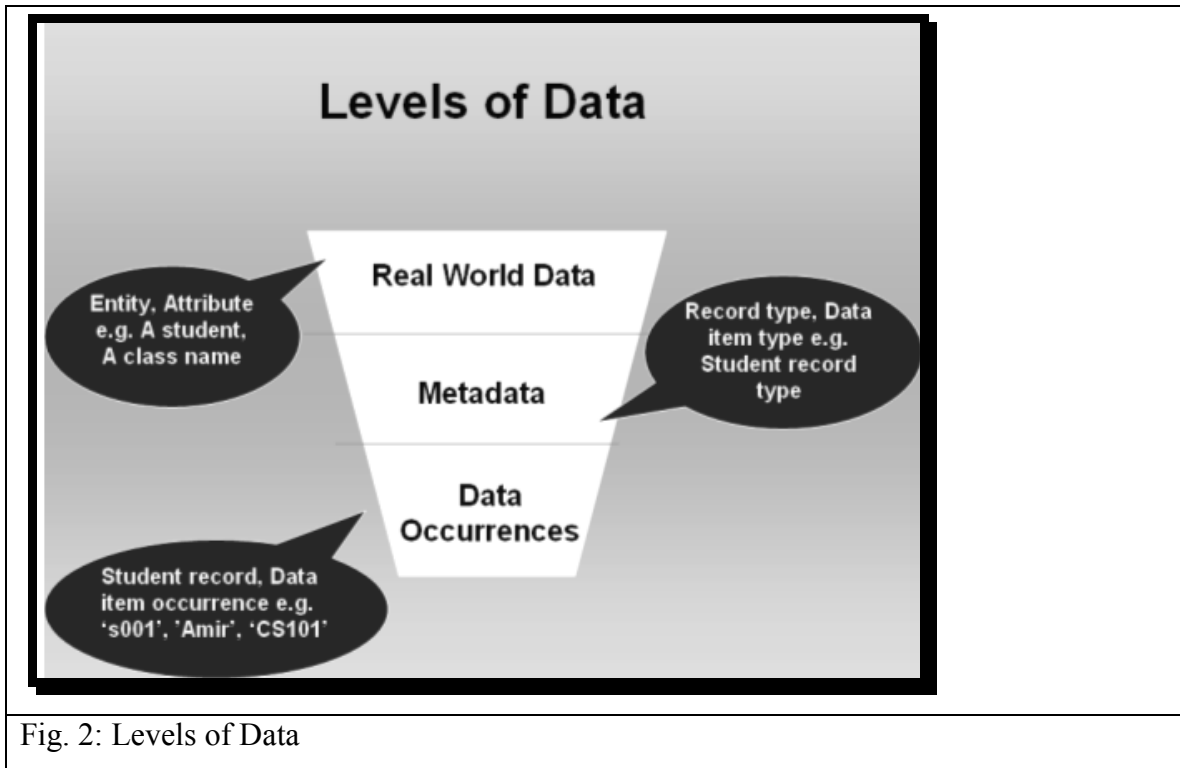

Fig. 2: Levels of Data

Users of Database Systems:

- Application Programmers
- End Users
 - Naïve
 - Sophisticated

○ **Application programmers:**

This category of database users contains those people who create different types of database application programs that we have seen earlier. Application programmers design the application according to the needs of the other users of the database in a certain environment. Application programmers are skilled people who have clear idea of the structure of the database and know clearly about the needs of the organizations.

○ **End Users:**

Second category of the Database users are the end users, this group of users contains the people who use the database application programs developed by the Application programmers. This category further contains two types of users:

- Naïve Users
- Sophisticated Users

- **Naïve Users**

This category of users is that category who simply use the application database programs created by the programmers. This group has no interaction with other parts of there database and only use the programs meant for them. They have not to worry about the further working of the database.

- **Sophisticated Users:**

This type of users has some additional rights over the Naïve users, which means that they can access the data stored in the database any of their desired way. They can access data using the application programs as well as other ways of accessing data. Although this type of users has more rights to access data, but these users have to take more responsibility and they need to be aware of the database structure. Moreover such users should be skilled enough to be able to get data from database with making and damage or loss to the data in database.

- **Database Administrators (DBA):**

This class of database users is the most technical class of db users. They need to have the knowledge of how to design and manage the database use as well as to manage the data in the database. DBA is a very responsible position in an organization. He is responsible for proper working of the database and DBMS, has the responsibility of making proper database backups and make necessary actions for recovering the database in case of a database crash. To fulfill the requirements of a DBA position a DBA needs vast experience and very elegant technical skills.

- **Duties of the DBA**

A Database administrator has some very precisely defined duties which need be performed by the DBA very religiously. A short account of these jobs is listed below:

- Schema definition
- Granting data access
- Routine Maintenance
 - Backups
 - Monitoring disk space
 - Monitoring jobs running

- **Schema Design**

DBA in some organization is responsible for designing the database schema, which means that DBA is the person who create all the meta data information for the organization on which the database is based. However in some very large scale organizations this job is performed by the database designer, which is hired for the purpose of database design and once the database system is installed and working, it is handed over to the DBA for further operation.

- **Granting Access to Users:**

DBA is also responsible for grant of access rights to the database users. Along with granting and revoking (taking back) the rights the DBA continuously monitors and ensure the legal use of these rights.

- **Monitoring Disk Space :**

When a new database is created it takes a limited space but as a result of daily activity the database acquires more data and grows in size very rapidly. The DBA has to monitor the disk space usage and statistics to ensure that no data over flow occurs at any stage.

- **Monitoring Running Jobs:**

To ensure the secure and proper functioning of the database system a DBA continuously monitors some associated activities also and ensure that all users are using their

authorities legally and different devices attached to the database system are functioning properly.

Typical Components of a Database Environment:

Different typical components of a database environment are shown in the figures below; they describe graphically the role of different types of users.

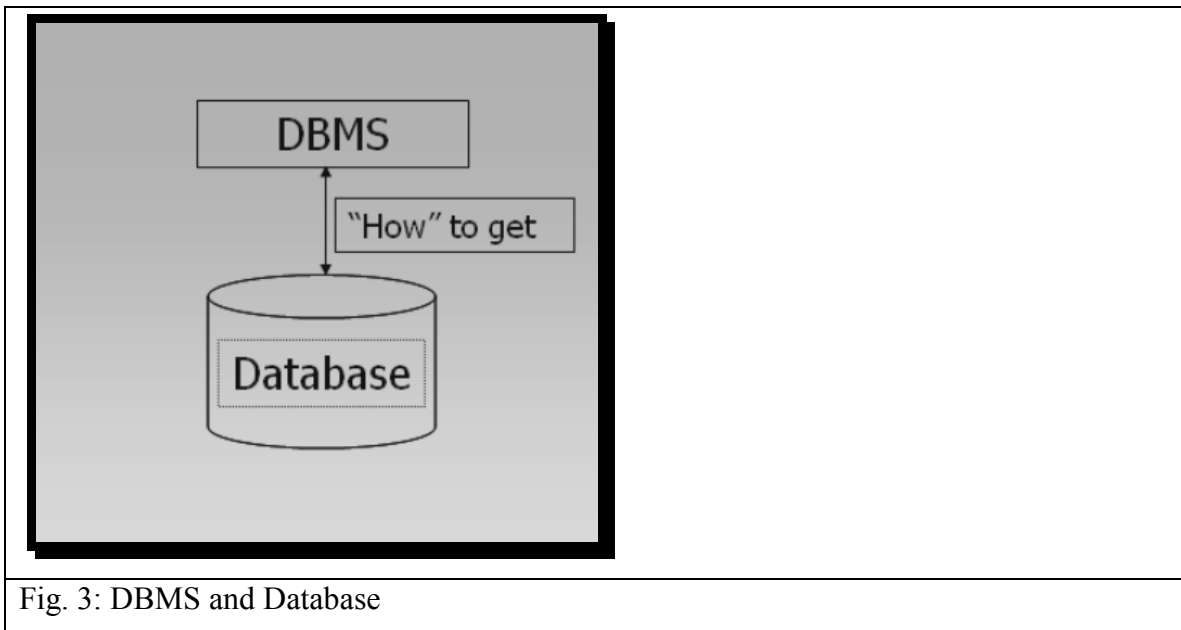
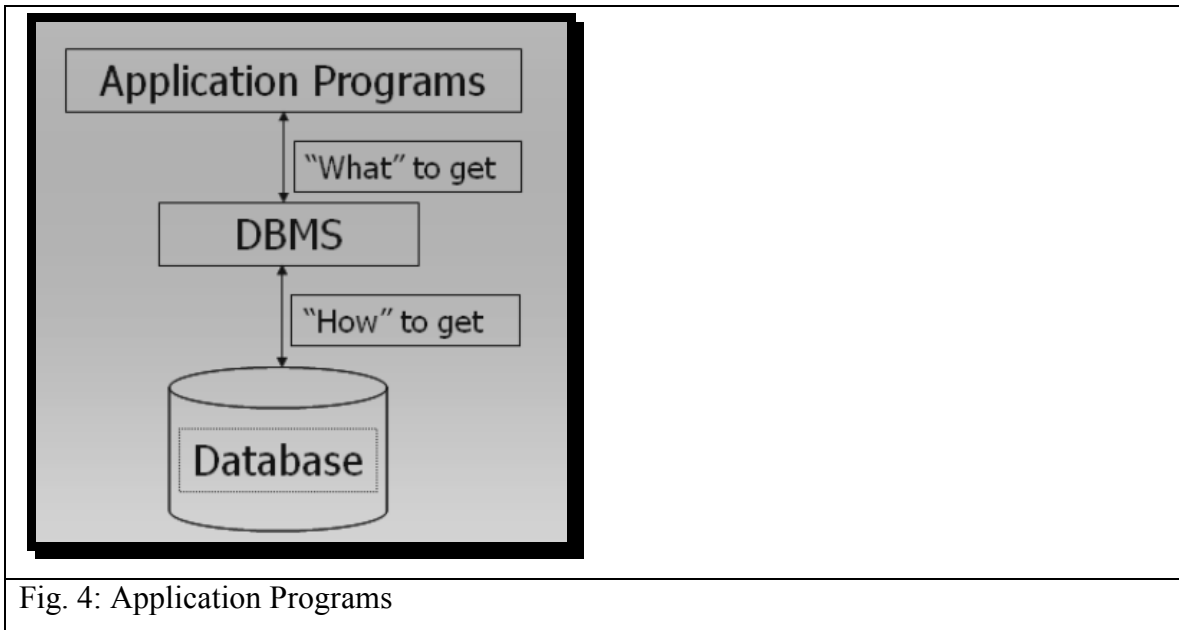
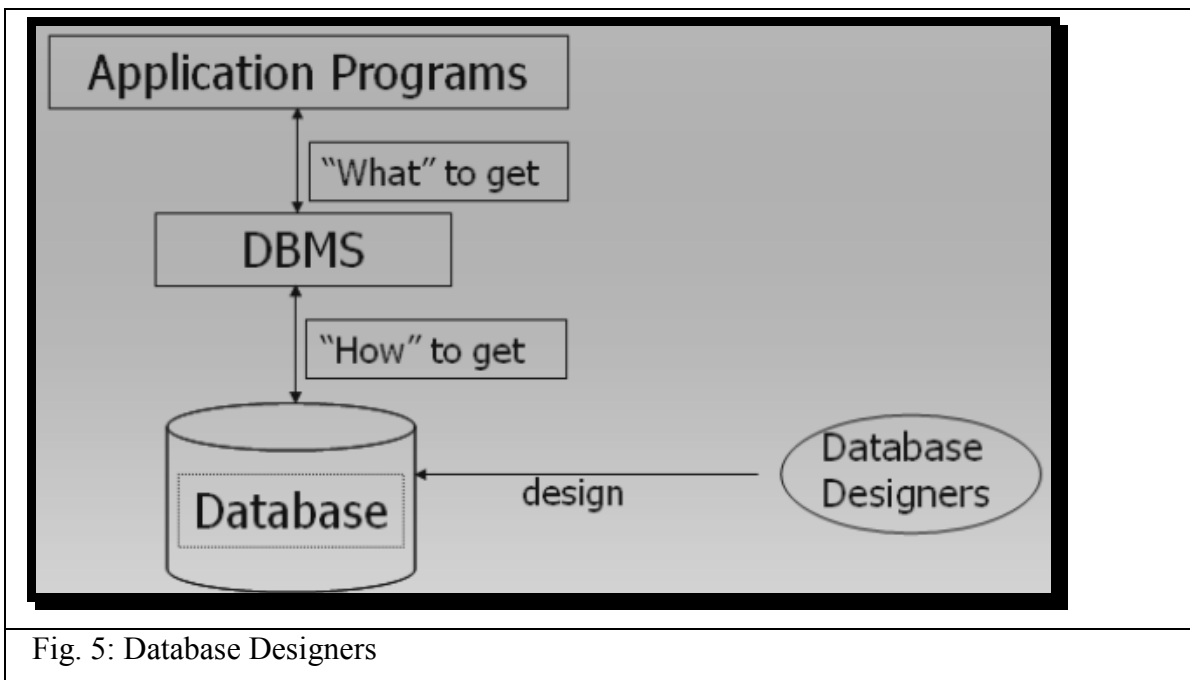

Fig. 3: DBMS and Database

Database is used to store data and DBMS uses mechanisms to get data from the database



Application programs talk to DBMS and ask for the data required



Database designers design (for large organizations) the database and install the DBMS for use by the users of the database in any specific organization.

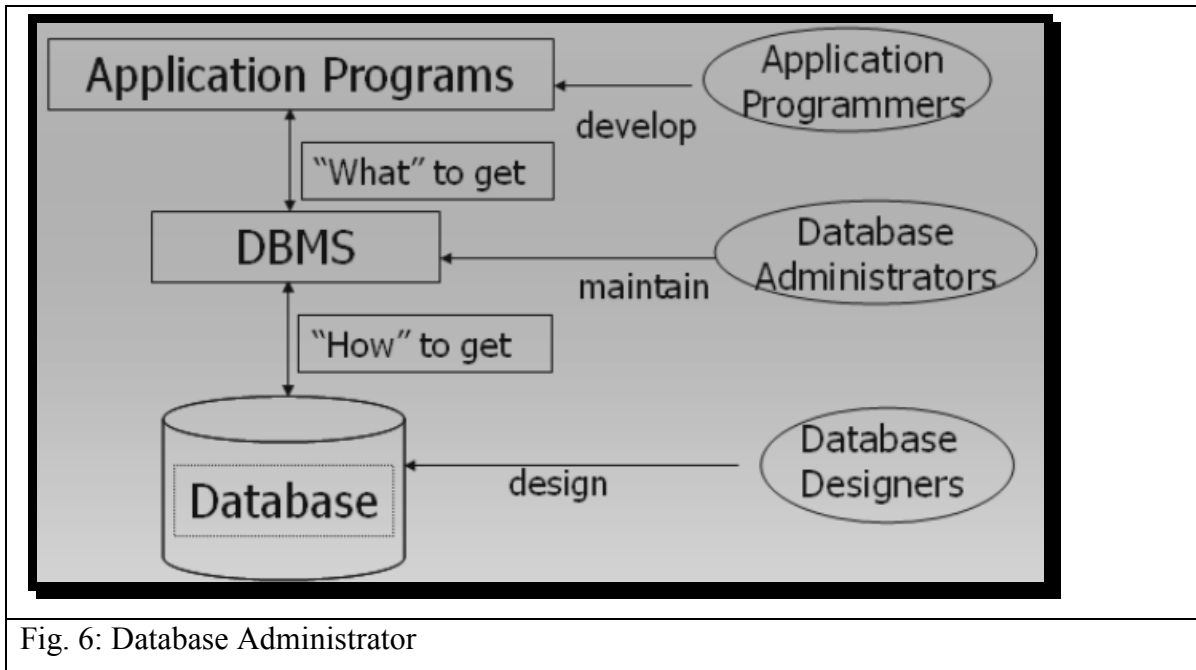

Fig. 6: Database Administrator

Once Database has been installed and is functioning properly in a production environment of an organization the Database Administrator takes over the charge and performs specific DBA related activities including:

- Database maintenance
- Database Backup
- Grant of rights to database users
- Monitoring of Running Jobs
- Managing Print jobs
- Ensuring quality of Service to all users

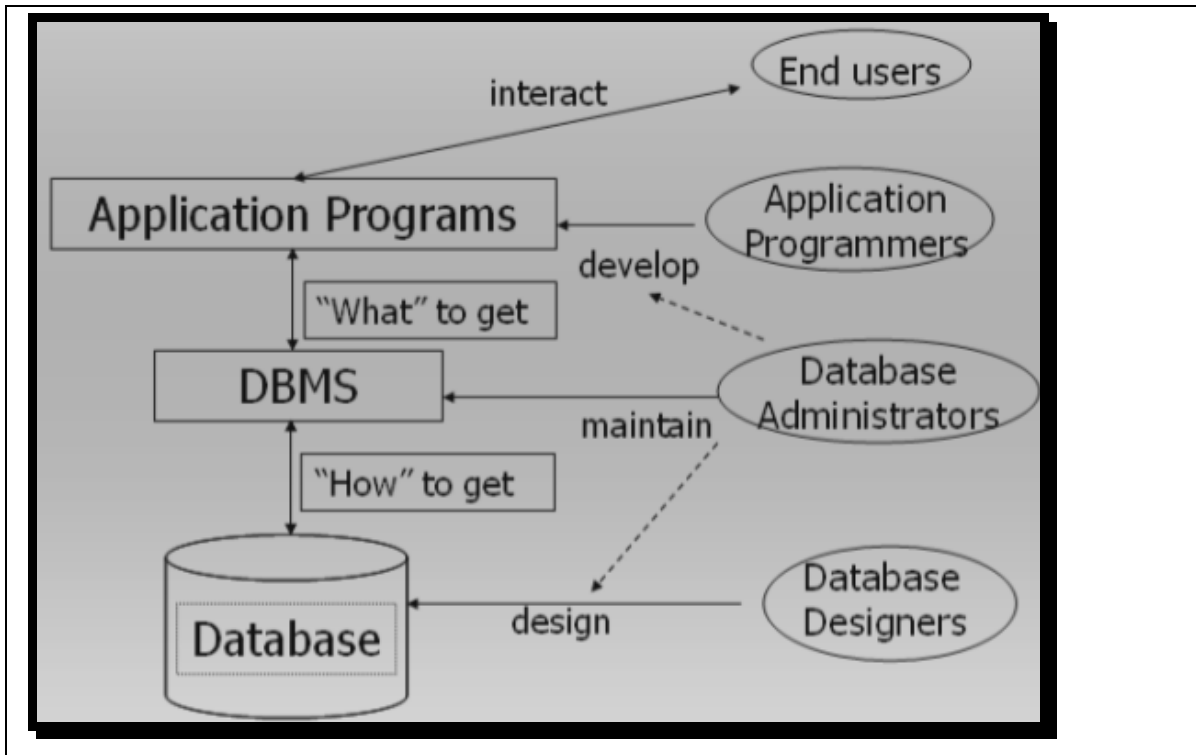

Fig. 7: Database Administration's interaction with other users

- Database administrator can interact with the database designer during database design phase so that he has a clear idea of the database structure for easy reference in future.
- This helps DBA perform different tasks related to the database structure.
- DBA also interacts with the application programmers during the application development process and provides his services for better design of applications.
- End users also interact with the system using application programs and other tools as specified in the description above.

This concludes lecture number 2, in case of any queries, please feel free to contact.

Lecture No. 03

Reading Material

“Database Systems Principles, Design and Implementation” written by Catherine Ricardo, Maxwell Macmillan.	Section: 4.1.1, 4.1.2
-----------------------------------------------------------------------------------------------------------	-----------------------

Overview of Lecture

- Database Architecture
- External View of the database
- Conceptual view of the database

Database Architecture:

Standardization of database systems is a very beneficent in terms of future growth, because once a system is defined to follow a specific standard, or is built on a specific standard, it provides us the ease of use in a number of aspects.

First if any organization is going to create a new system of the same usage shall create the system according to the standards and it will be easier to develop, because the standards which are already define will be used for developing the system.

Secondly if any organization wants to create and application software that will provide additional support to the system, it will be an easier task for them to develop such system and integrate them into existing database applications.

Users which will be using the system will be comfortable with the system because a system built on predefined standards is easy to understand and use, rather than understanding learning and using an altogether new system which is designed and built without following any standards.

Expansion to systems which are not built on standards is very hard and needs lots of efforts.

Technical staff working on a system built on standard has no problem to learn the use and architecture of the system and whenever there is a need in change of staff new staff members can be hired and put to work without any prior training for the use of system.

Database standard proposed by ANSI SPARK in 1975 is being used worldwide and is the only most popular agreed upon standard for database systems.

The Three Level Schema architecture provides us a number of benefits. For accessing data at different levels we have a number of users because not all users have to access data in database at all the database levels. The 3 levels architecture allows us to separate the physical representation of data from the users' views of data.

In the database, same data is stored in a specific feasible format and is available to different users in different formats as desired by different users. For example, consider we have stored the DOB (Date of Birth) in the database in a particular format, like in the form of dd-mm-yyyy (for example, 28-03-1987). However, the users from different departments may require to view the date of birth in different forms; the examination department may ask it to be displayed as month-day-yyyy (like march-28-1987) the Registrar's office may ask to display date of birth as mm/dd/yyyy, still the Library may need the in the form of dd/mm/yy. The Three Level Schema allows us to access the data in different formats at the external level, which is stored in a specific format at the internal level.

The Three levels architecture is useful for hiding the details of internal systems; it in-fact hides the details of underlying system views from the users at other levels and restricts the access of data and the system from any unauthorized intervention. It is the mechanism which allows us to store the data in the system in such a way that it can be provided to all users in their desired formats and with unveiling other details and information stored in the database. Moreover if there is a change to be done to the data stored in the database subject to the

requirements of a specific user it needs not be changed for that user specifically, we can create a change to the specific external view of that user and the internal details remain unchanged. Also if we want to change the underlying storage mechanism of the data stored on the disk we can do it without affecting the internal and conceptual view at the lowest level in the three levels architecture is the internal view or internal level which is shown below in the diagram and is illustrated in the coming lines.

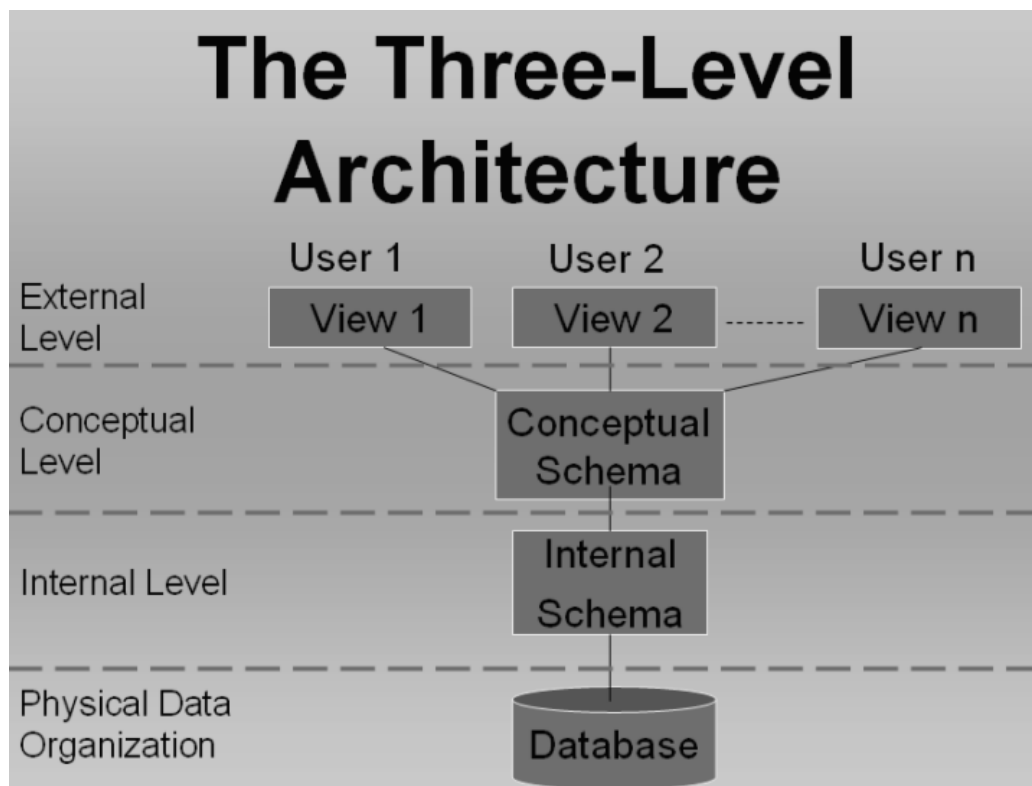

Fig. 1: Three level architecture of database

The Architecture:

The schemas as it has been defined already; is the repository used for storing definitions of the structures used in database, it can be anything from any entity to the whole organization. For this purpose the architecture defines different schemas stored at different levels for isolating the details one level from the other.

Different levels existing at different levels of the database architecture are expressed below with emphasis on the details of all the levels individually.

Core of the database architecture is the internal level of schema which is discussed a bit before getting into the details of each level individually. The internal level implements all the inner details and defines the intentions of the database. Internal schema or view defines the structures of the data and other data related activities in the database. For example it defines that for a student what data will be stored in terms of attributes of the student and it also defines how different values for these attributes will be stored, also it tells that who is allowed to make changes to the database and what changes he can make, etc.

These details give us the internal schema and are called the intention of the database. **Intention** for a database is almost permanent, because while designing the database it is ensured that no information is left behind which is important enough to be stored in the database and what information is important to be stored in the database from the future point of view.

Once the intention of the database has been defined then it is undesirable to change the intention for any reason. Because any small change in the intention of the database may need a lot of changes to be made to the data stored in the database. **Extension** of the database is performed on the bases of a complete intention, i-e once a database has been defined it is populated with the data of the organization for which the database is created. This population of the database is also called as the extension of the database. Extension is always done according to the rules defined in the internal schema design or the intention of the database.

Effects of changes made to different levels of the database architecture:

We can make changes to the different levels of the database but these changes need very serious consideration before they are made, Changes at different levels of database architecture need different levels of users attention for example a change to the data made for the extension of data will effect only a single record whereas when we make a change to the internal level of the

database the change effects all the stored records, similarly an invalid change in the extension of the database is not that fatal as a change in the intention of the database because a change in the extension of the database is not very hard to undo; in case of a mishap whereas a change of the same magnitude to the intention of the database might cause a large number of database errors (inconsistencies and data loss).

External View (Level, Schema or Model):

This level is explicitly an end user level and presents data as desired by the users of the database. As it is known that the database users are classified on two grounds

- Section of the organization
- Nature of Job of the users

The external level of the database caters to the needs of all the database users starting from a user who can view the data only which is of his concern up to the users who can see all the data in the database and make all type of actions on that data.

External level of the database might contain a large number of user views, each user view providing the desired features and fulfilling requirements for the user or user group for which it is intended. The restriction or liberty a user or user groups get in his rights is the external view of that user groups and is decided very carefully.

External views are also helpful when we want to display the data which is not place in the database or not stored at all. Example of the first case can be a customer Phone number stored in the database. But when contacting the person it might appear that the area code for that specific user is not stored in the database, in that case we can simply pick up the area or city id of the customer and find the area code for that city from the corresponding Area Codes table.

Another situation may arise when we want to get a student enrolled in an institution and want to make sure that the student qualifies for the minimum required age limit, we will look the database, for the students age but if we have

stored only the date of birth of the student then the age of the student needs to be calculated at that very instance; this can be done very easily in the specific user view and age of the student can be calculated, even the user-view itself can tell use whether the student qualifies for the admission or not.

As the user view is the only entity or the interface through which a user will operate the database or use it so it must be designed in such a way that it is easy to use and easy to manage and self descriptive, also it is easy to navigate through. Also it should not allow the user to get or retrieve data which is not allowed to the user, so the user view should both be a facilitator and also a barrier for proper utilization of the database system.

As the system grows it is possible that a user view may change in structure, design and the access it provides to the users. SO External views are designed and create in way that they can be modified at a later stage without making any changes in the logical or internal views.

In the diagram below we can see two different users working as end users having their own external view; we can see that the same data record is displayed in two entirely different ways.

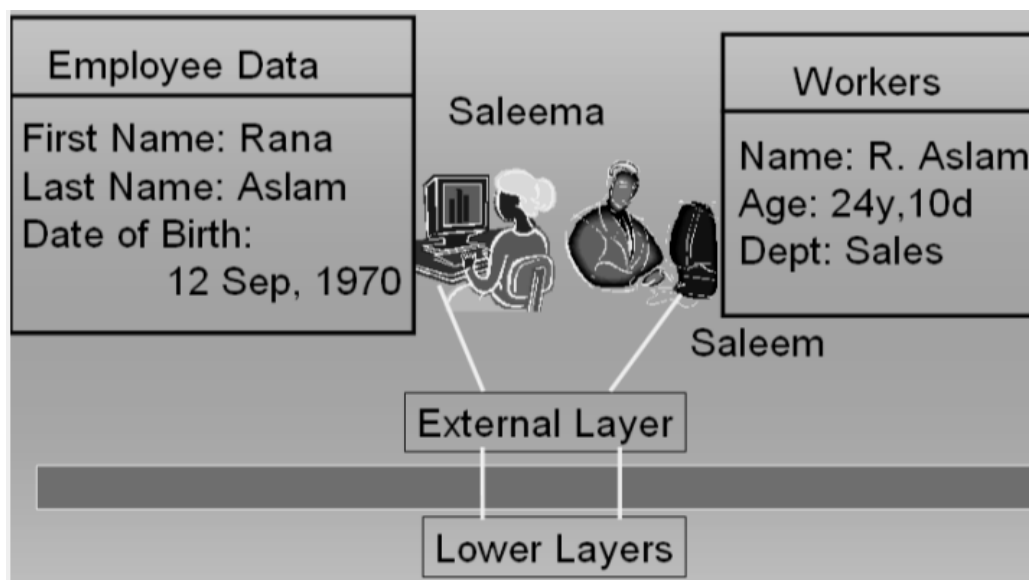

Fig. 2: Mapping between External layer and lower layers

Conceptual or Logical View:

This is the level of database architecture which contains the definition of all the data to be stored in the database and also contains rules and information about that structure and type of that data.

The conceptual view is the complete description of the data stored in the database. It stores the complete data of the organization that is why it is also known as the community view of the database. The conceptual view shows all the entities existing in the organization, attribute or characteristics associated with those entities and the relationships which exist among the entities of the organization.

We can take the example of the customers of a company. Now the conceptual schema will have all the details of the products of the company, retailing stores of the company, products present in the stock, products which are ready to be delivered, salespersons of the company, manager of the company and literally every other thing which is associated with the business of the company in any way.

Now after having all the information we know that the customers buy products from the outlets of the company, thus in such a case a specific customer has a relationship with that specific outlet of the company, or the customer may be represented as having association with the sales person which in-turn has association with the outlet., there may be a number of customers at a certain outlet and also to manage these salespersons there will be one or more managers. We can see from the above given scenario that all the entities are logically related to each other in way or the other. The conceptual schema actually manages all such relationship and maps these relationships among the member entities. Conceptual schema along-with having all the information which is to be stored in the database stores the definition of the data to be stored. The definition may contain types of data, and constraints on data values etc.

Conceptual schema is also responsible for holding the authorization and authentication information, means that only those people can make use of the database whom we have allowed to make these changes, so therefore it is the task of the DBMS to ensure be checking the conceptual schema that he is authorized to check the data or make any changes to the data.

Conceptual schema as it describes the intention of the database; it is not changed often, because to make a change to the conceptual schema of the database requires lots of consideration and may involve changes to the other views/levels of the database also.

As in the previous example we saw two database users accessing the database and we saw that both of them are having totally different user views. Here when we see in the logical view of the data we can see that the data stored in the database is stored only once and two users get different data from the same copy of data at the underlying conceptual level.

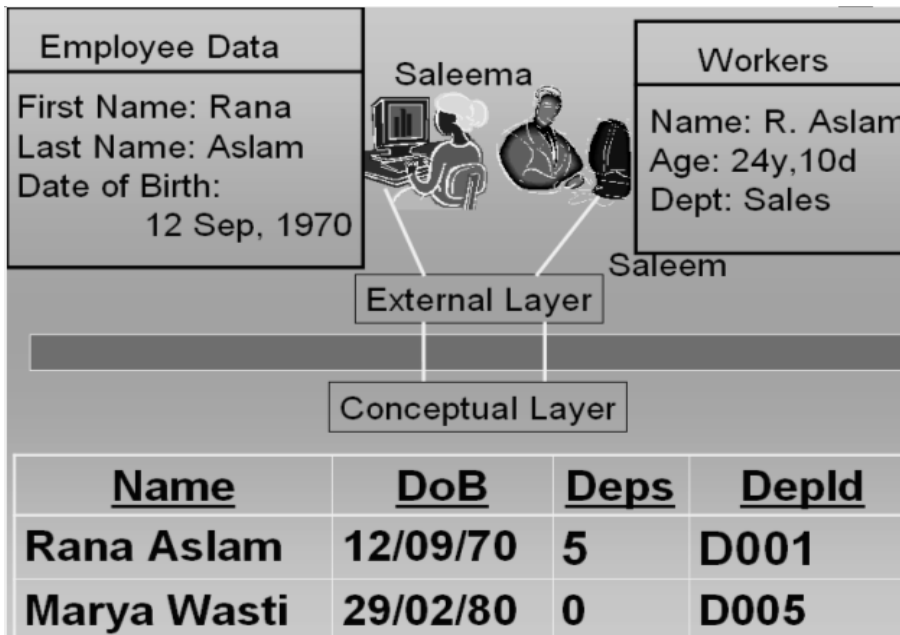

Fig. 3: External and conceptual layers

By summarizing it all we can say that the external view is the view of database system in which user get the data as they need and these database users need

not to worry about the underlying details of the data, all these users have to do is to provide correct requirement information to the DBA or the database designer whoever is designing the database for the system, so that the DBA or the database designer can create the database in such a way that they can fulfill the users requirements using the conceptual schema of the database.

Conceptual view/schema is that view of the database which holds all the information of the database system and provides basis for creating any type of the required user views and can accommodate any user fulfilling his/her requirements.

Exercise:

The data examples that you defined in the exercises of lecture 1, think of the different forms of data at the external and conceptual level. Also try to define mapping between them.

Lecture No. 04

Reading Material

"Database Systems Principles, Design and Implementation" written by Catherine Ricardo, Maxwell Macmillan.	4.1.3, 4.1.4
Hoffer	Chapter 2

Overview of Lecture

- Internal Schema of the Database Architecture
- Data Independence
- Different aspects of the DBMS

Internal or Physical View / Schema

This is the level of the database which is responsible for the storage of data on the storage media and places the data in such a format that it is only readable by the DBMS. Although the internal view and the physical view are so close that they are generally referred to a single layer of the DBMS but there lays thin line which actually separated the internal view from the physical view. As we know that data when stored onto a magnetic media is stored in binary format, because this is the only data format which can be represented electronically, No matter what is the actual format of data, either text, images, audio or video. This binary storage mechanism is always implemented by the Operating System of the Computer. DBMS to some extent decides the way data is to be stored on the disk. This decision of the DBMS is based on the requirements specified by the DBA when implementing the database. Moreover the DBMS itself adds information to the data which is to be stored. For example a DBMS has selected a specific File organization for the

storage of data on disk, to implement that specific file system the DBMS needs to create specific indexes. Now whenever the DBMS will attempt to retrieve the data back from the file organization system it will use the same indexes information for data retrieval. This index information is one example of additional information which DBMS places in the data when storing it on the disk. At the same level storage space utilization is performed so that the data can be stored by consuming minimum space, for this purpose the data compression can be performed, this space optimization is achieved in such a way that the performance of retrieval and storage process is not compromised. Another important consideration for the storage of data at the internal level is that the data should be stored in such a way that it is secure and does not involve any security risks. For this purpose different data encryption algorithms may be used. Lines below detail further tidbits of the internal level.

The difference between the internal level and the external level demarcates a boundary between these two layers, now what is that difference, it in fact is based on the access or responsibility of the DBMS for the representation of data. At the internal level the records are presented in the format that are in match with schema definition of the records, whereas at the physical level the data is not strictly in record format, rather it is in character format., means the rules identified by the schema of the record are not enforced at this level. Once the data has been transported to the physical level it is then managed by the operating system. Operating system at that level uses its own data storage utilities to place the data on disk.

Inter Schema Mapping:

The mechanism through which the records or data at one level is related to the changed format of the same data at another level is known as mapping. When we associate one form of data at the external level with the same data in another form is known as the external/conceptual mapping of the data. (We have seen examples of external/conceptual mapping in the previous lecture) In the same way when data at the conceptual level is correlated with the same data at the internal level, this is called the conceptual/Internal mapping.

Now the question arises that how this mapping is performed. Means how is it possible to have data at one level in date format and at a higher level the same data show us the age. This hidden mechanism, conversion system or the formula which converts the date of birth of an employee into age is performed by the mapping function and

it is defined in the specific ext/con mapping, for example, when the data at the conceptual level is presented as the age of the employee is done by the external schema of that specific user. Now in this scenario the ext/con mapping is performing the mapping with the internal view and is retrieving the data in desire format of the user. In the same way the mapping between an internal view and conceptual view is performed.

The figure below gives a clear picture of this mapping process and informs where the mapping between different levels of the database is performed.

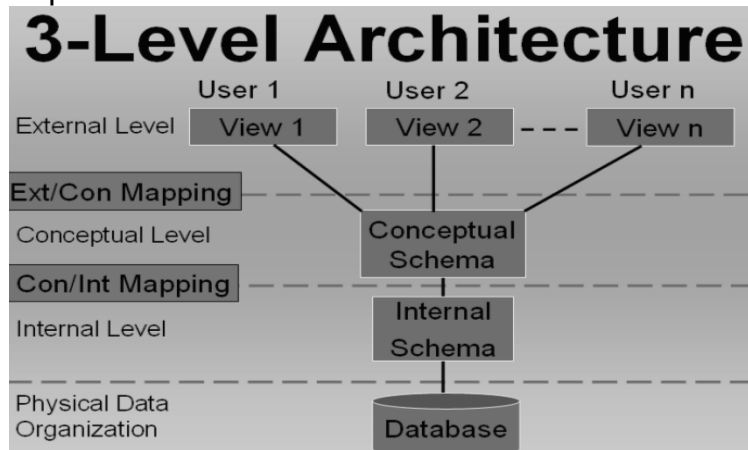

Fig:1: Mapping between External/Conceptual and Conceptual/Internal levels

In Figure-1 we can see clearly where the mapping or connectivity is performed between different levels of the database management system. Figure-1 is showing another very important concept that the internal layer and the physical layers lie separately the Physical layer is explicitly used for data storage on disk and is the responsibility of the Operating system. DBMS has almost no concern with the details of the physical level other than that it passes on the data along-with necessary instructions required to the store that data to the operating system.

Figure-2 on the next page shows how data appears on different levels of the database architecture and also at that of physical level. We can clearly see that the data store on the physical level is in binary format and is separate from the internal view of data in location and format. Separation of the physical level from the internal level is of great use in terms of efficiency of storage and data retrieval.

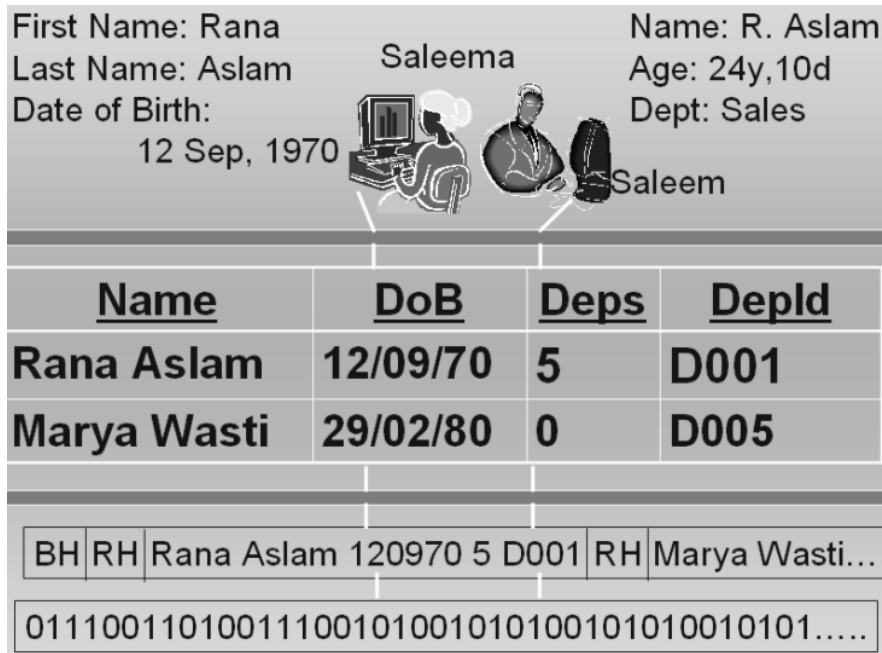

Fig: 2. Representation of data at different levels of data base Architecture and at the physical level at bottom

At the internal level we can see that data is prefixed with Block Header and Record header RH, the Record header is prefixed to every record and the block header is prefixed to a group of records; because the block size is generally larger than the record size, as a result when an application is producing data it is not stored record wise on the disk rather block wise which reduces the number of disk operations and in-turn improves the efficiency of writing process.

Data Independence:

Data Independence is a major feature of the database system and one of the most important advantages of the Three Level Database Architecture. As it has been discussed already that the file processing system makes the application programs and the data dependent on each other, I-e if we want to make a change in the data we will have to make or reflect the corresponding change in the associated applications also.

The Three Level Architecture facilitates us in such a way that data independence is automatically introduced to the system. In other words we can say the data independence is major most objective of the Three Level Architecture. If we do not have data independence then whenever there will be a change made to the internal or

physical level or the data accessing strategy the applications running at the external level will demand to be changed because they will not be able to properly access the changed internal or physical levels any more. As a result these applications will stop working and ultimately the whole system may fail to operate.

The Data independence achieved as a result of the three level architecture proves to be very useful because once we have the data , database and data applications independent of each other we can easily make changes to any of the components of the system, without effecting the functionality and operation of other interrelated components.

Data and program independence is on advantage of the 3-L architecture the other major advantage is that ant change in the lower level of the 3-L architecture does not effect the structure or the functionality on upper levels. I-e we get external/conceptual and conceptual/internal independence by the three levels Architecture.

Data independence can be classified into two type based on the level at which the independence is obtained.

- **Logical Data Independence**
- **Physical Data Independence**

Logical data independence

Logical data independence provides the independence in a way that changes in conceptual model do not affect the external views. Or simply it can be stated at the Immunity of external level from changes at conceptual level.

Although we have data independence at different levels, but we should be careful before making a change to anything in database because not all changes are accepted transparently at different levels. There may be some changes which may cause damage or inconsistency in the database levels. The changes which can be done transparently may include the following:

- Adding a file to the database
- Adding a new field in a file
- Changing the type of a specific field

But a change which may look similar to that of the changes stated above could cause problems in the database; for example: Deleting an attribute from the database structure,

This could be serious because any application which is using this attribute may not be able to run any more. So having data independence available to us we still get problem after a certain change, it means that before making a certain change its impact should also be kept in mind and the changes should be made while remaining in the limits of the data independence.

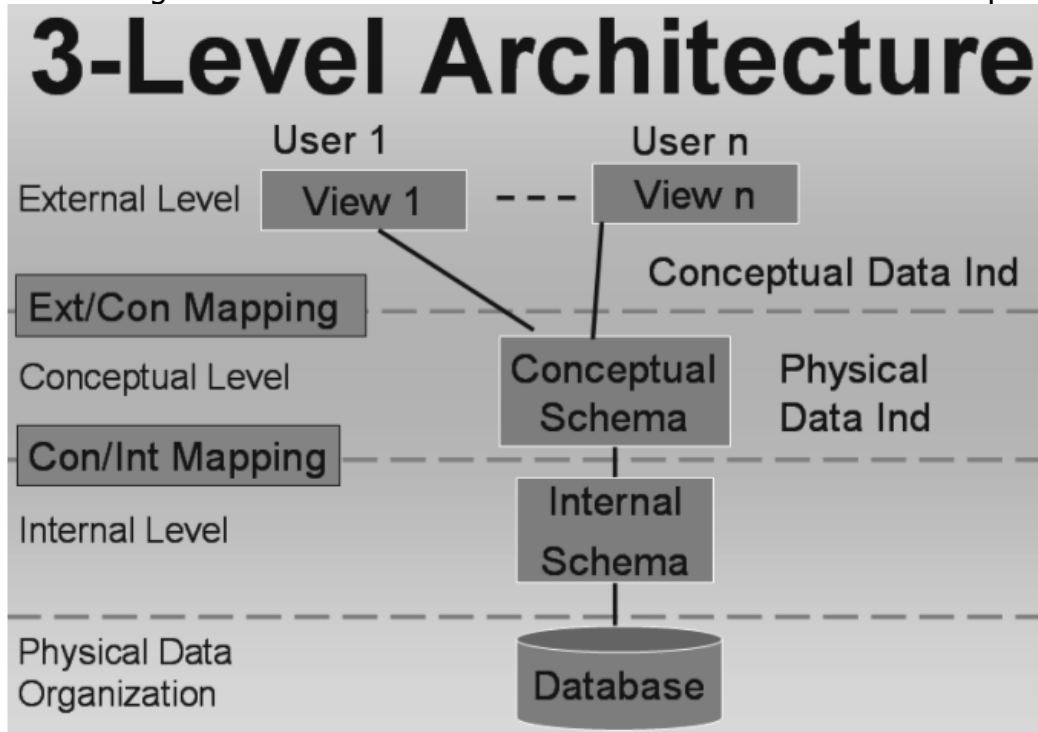

Fig:3. The levels where the Conceptual and Physical data independence are effective

Physical Data Independence

Physical data independence is that type of independence that provides us changes transparency between the conceptual and internal levels. I-e the changes made to internal level shall not affect the conceptual level. Although the independence exist but as we saw in the previous case the changes made should belong to a specific domain and should not exceed the liberty offered by the physical data independence. For example the changes made to the file organization by implementing indexed or sequential or random access at a later stage, changing the storage media, or simply implement a different technique for managing file indexes or hashes.

Functions of DBMS

- **Data Processing**

- **A user accessible Catalog**
- **Transaction Support**
- **Concurrency Control Services**
- **Recovery Services**
- **Authorization Services**
- **Support for Data Communication**
- **Integrity Services**

DBMS lies at the heart of the course; it is the most important component of a database system. To understand the functionality of DBMS it is necessary that we understand the relation of database and the DBMS and the dissection of the set of functions the DBMS performs on the data stored in the database.

Two important functions that the DBMS performs are:

- User management**
- Data Management**

The detailed description of the above two major activities of DBMS is given below;

- **Data Processing**

By Data management we mean a number of things it may include certain operations on the data such as: creation of data, Storing of the data in the database, arrangement of the data in the databases and data-stores, providing access to the data in the database, and placing of the data in the appropriate storage devices. These action performed on the data can be classified as data processing.

- **A User Accessible Catalog**

DBMS has another very important task known as access proviso to catalog. Catalog is an object or a place in the DBMS which stores almost all of the information of the database, including schema information, user information right of the users, and many more things about the database. Modern relational DBMS require that the Administrative users of the database should have access to the catalog of the database.

- **Transaction Support**

DBMS is responsible for providing transaction support. Transaction is an action that is used to perform some manipulation on the data stored in the database. DBMS is responsible for supporting all the required operations on the database, and also manages the

transaction execution so that only the authorized and allowed actions are performed.

- **Concurrency Support**

Concurrency support means to support a number of transactions to be executed simultaneously, Concurrency of transactions is managed in such a way that if two or more transactions is making certain processing on the same set of data, in that case the result of all the transactions should be correct and no information should be lost.

- **Recovery Services**

Recovery services mean that in case a database gets an inconsistent state to get corrupted due to any invalid action of someone, the DBMS should be able to recover itself to a consistent state, ensuring that the data loss during the recovery process of the database remains minimum.

- **Authorization Services**

The database is intended to be used by a number of users, who will perform a number of actions on the database and data stored in the database, The DBMS is used to allow or restrict different database users to interact with the database. It is the responsibility of the database to check whether a user intending to get access to database is authorized to do so or not. If the user is an authorized one than what actions can he/she perform on the data?

- **Support for Data Communication**

The DBMS should also have the support for communication of the data indifferent ways. For example if the system is working for such an organization which is spread across the country and it is deployed over a number of offices throughout the country, then the DBMS should be able to communicate to the central database station. Or if the data regarding a product is to be sent to the customers worldwide it should have the facility of sending the data of the product in the form of a report or offer to its valued customers.

- **Integrity Services**

Integrity means to maintain something in its truth or originality. The same concept applies to the integrity in the DBMS environment. Means the DBMS should allow the operation on the database which are real for the specific organization and it should not allow the false information or incorrect facts.

DBMS Environments:

- **Single User**
- **Multi-user**
 - **Teleprocessing**
 - **File Servers**
 - **Client-Server**

- **Single User Database Environment**

This is the database environment which supports only one user accessing the database at a specific time. The DBMS might have a number of users but at a certain time only one user can log into the database system and use it. This type of DBMS systems are also called Desktop Database systems.

- **Multi-User Database systems**

This is the type of DBMS which can support a number of users simultaneously interacting with the database in different ways. A number of environments exist for such DBMS.

- **Teleprocessing**

This type of Multi user database systems processes the user requests at a central computer, all requests are carried to the central computer where the database is residing, transactions are carried out and the results transported back to the terminals (literally dumb terminals). It has become obsolete now.

- **File Servers**

This type of multi-user database environment assumes another approach for sharing of data for different users. A file server is used to maintain a connection between the users of the database system. Each client of the network runs its own copy of the DBMS and the database resides on the file server. Now whenever a user needs data from the file server it makes a request the whole file containing the required data was sent to the client. At this stage it is important to see that the user has requested one or two records from the database but the server sends a complete file, which might contain hundreds of records. Now if the client after making the desired operation on the desired data wants to write back the data on the database he will have to send the whole file back to the server, thus causing a lot of network overhead. The Good thing about this approach is that the server does not have lots of actions to do rather it remains idle for lots of the time in contrast with that of the teleprocessing systems approach.

- **Client-Server**

This type of multi-user environment is the best implementation of the network and DBMS environments. It has a DBMS server machine which runs the DBMS and to this machine are connected the clients having application programs running for each user. Once a users wants to perform a certain operation on data in the database it sends its requests to the DBMS through its machine's application software; the request is forwarded to the DBMS server which performs the required operation on data in the database stored in the same computer and then passes back the result to the user intending the result. This environment is best suited for large enterprises where bulk of data is processed and requests are very much frequent.

This concludes the topics discusses in the lecture No4. In the next lecture Database application development process will be discussed

Exercises:

- Extend the format of data from the exercise of previous lecture to include the physical and internal levels. Complete your exercise by including data at all three levels
- Think of different nature of changes at all three levels of database architecture and see, which ones will have no effect on the existing applications, which will be adjusted in the inter-schema mapping and which will effect the existing applications.

Lecture No. 05

Reading Material

“Database Systems Principles, Design and Implementation” written by Catherine Ricardo, Maxwell Macmillan.	2.3.2, 2.4
--------------------------------------------------------------------------------------------------------------	------------

Overview of Lecture

- Database Application Development Process
- Preliminary Study of System
- Tools used for Database system Designing
- Data Flow Diagrams
- Different types of Data flow Diagram

Database design and Database Application design are two almost similar concepts, from the course point of view it is worthwhile to mention that the course is mainly concerned with designing databases and it concentrates on the activities which are performed during the design of database and the inner working of the database. The process that will be discussed in this lecture for development of database is although not a very common one, but it specifies all the major steps of database development process very clearly. There exist many ways of system and database development which are not included in the scope of this course. But we will see only those portions of the other processes which are directly related with the design and development of database.

Database Application development Process includes the Following Stages or steps:

- **Database Design**
- **Application Programs**
- **Implementation**

These three steps cannot always be considered as three independent steps performed in a sequence or one after another. Rather, they occur in parallel, which means that from a certain point onward the application programs development may run in parallel with the database design stages, specially the last stages of the database design. Similarly while the design phases of the database are in progress, certain phases of the application programs can also be initiated, for example, the initial study of the screens' format or the reports layout. The database design process that we are going to discuss in this course does not take these steps independently and separately, and since the major concern of this course is the design stages of the database, it concentrate only on those.

- **Database Design:**

This part of the database application development process is most important process with respect to the database application development, because the database is something that will hold the organizations' data, in case the design of the database is not correct or is not correctly reflecting the situations or scenarios of the organization then it will not produce correct result, or even just produce errors in response to certain queries. So this portion of the database design is given great attention when designing a database application.

Database Development Process

The database development process means the same thing that we have mentioned as database application development process. Rather than discussing three stages of database application development separately, the steps given in the database development process include steps that cover all three phases mentioned for the database application development process.

Preliminary Study:

Design of database is carried out in a number of steps; these steps play important role in the design process and need to be given proper attention First Phase of the database development process is the Preliminary Stage, which is based on the proper study of the system. It means that all the parts of the systems, or the section of the subject

organization for which we intend to develop the system must be studied. We should find the relation or interaction of different section of the organization with each other and should understand the way information flows between different sections of the organization. Moreover it should also be made clear that what processing is performed at each stage of the system.

- **Requirement Analysis:**

Once we have investigated the organization for its different sections and the way data flows between those sections. Detailed study of the system is started to find out the requirements of each section. This phase is the detailed study of the system and its functionality decisions made at this stage decide the overall activity of the organization. Requirements of one section of the organization are fulfilled in such a way that all the sections in the organization are supporting each other, for example we can say that the results produced by the processing taking place at one section are used as input for another section. All the users of the systems are interviewed and observed to pinpoint and precisely define the activities taking place in the different section of the organization.

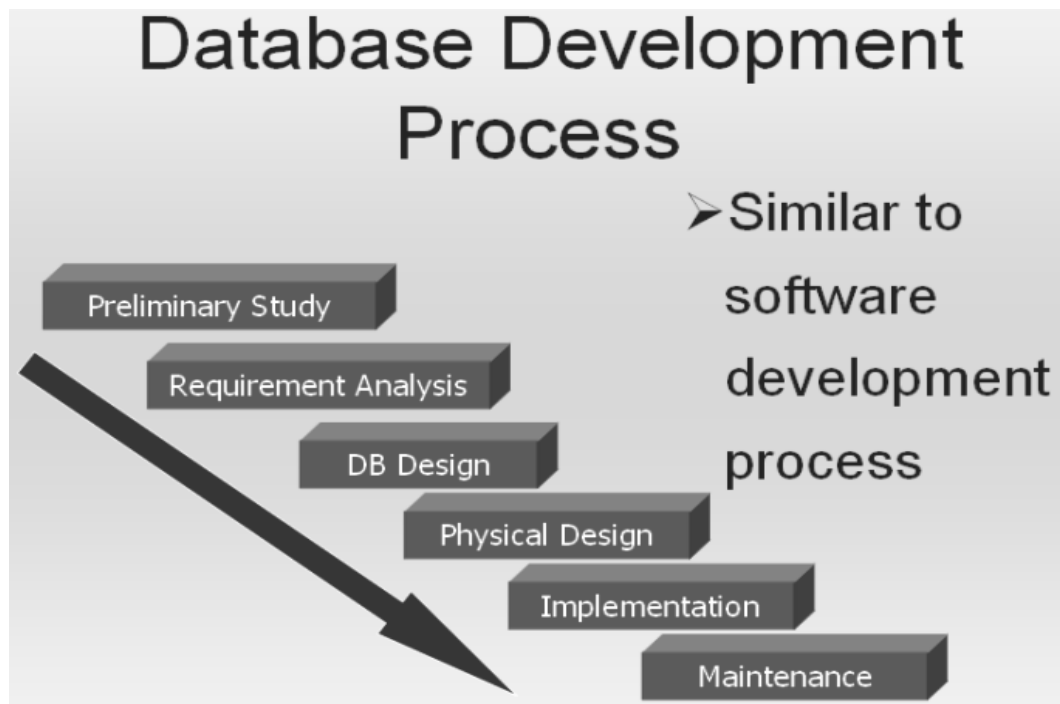

Fig: 1. Database Development process

- **Database Design:**

Third stage in the database development process is the database design; this is a rather technical phase of the process and need handsome skill as a Database Administrator. This is the phase where the logical design of the database is created and different schemas for the database are created logically. Entities are identified and given attributes, relationships are built and different types of entity mappings are performed.

- **Physical Design**

This is the phase where we transform our logical design into a Physical design by implementing the designed database onto a specific DBMS; the choice of the DBMS is made on the basis of requirements and the environment in which the system will operate. Implementing a database on a specific DBMS is very important because it involves the major financial investment of the organization, and can not be reverted in case a selected DBMS is not capable of providing the desired efficiency.

- **Implementation:**

This phase is specific to writing the application programs needed to carry out different activities according to use requirements. Different users may have different requirements of the data in the database, so the number of application programs is not known or fixed for all the organizations, it may vary for different organizations.

- **Maintenance of the Database System:**

Maintenance means to fine tune the system and check that the designed applications systems are fulfilling the purpose for which they are meant. Also this phase may involve designing any new application for the enhancement of the system. Or an already working application may need to be updated or modified to remove any errors or to add some functionality in the system. The phases involved in the development of the database application are expressed graphically in Figure-1.

All these stages are necessary and must be given the necessary attention at each level to get properly working and good system design and a better working environment.

Database Development Process: Approach 2

There are other development processes also with some of the stages or steps modified as compared to the model we have just studied. Such an alternative is given in the Figure-2 below. In this design process we see some of the design stages which existed in the previous designing steps but some of the stages are modified or merged with others to get more precise result or to distinguish different separate design phases. In this process of designing; the following steps exist:

- Analyze User Environment
- Develop Conceptual Model
- Map Conceptual Model to Logical
- Choose DBMS
- Develop Physical Design
- Implement System
- Test System
- Operational Maintenance

- **Analyze User Environment**

This is same step as we discussed while discussing the previous designing process

- **Develop Conceptual Model**

Next stage in this process model is the development of conceptual model or schema. Here we actually transform the studied and analyzed information into the conceptual design of the database, this stage may also be connected with the requirement analysis phase, as expressed in the diagram by showing an arrow from this stage back to the first stage.

- **Map Conceptual Model to Logical Model**

Third stage is the mapping of the developed conceptual model to the logical model of the database, means at this stage the schema rules are defined and identified for general database structures.

- **Choose DBMS**

Once the mapping of the conceptual and logical model is done, the decision for the use of DBMS is made; again we refer to the previous model for selecting of the DBMS and will take care of all the necessary requirements of the environment before making a decision.

- **Develop Physical Design**

Once we have selected a DBMS, the logical design is then transformed into physical design. This also includes considering many other decisions, like, data type allocation, indexes to be created, file organizations, etc. Physical database design is achieved by using the DBMS specific rules for schema definition and all the facilities provided by the DBMS,

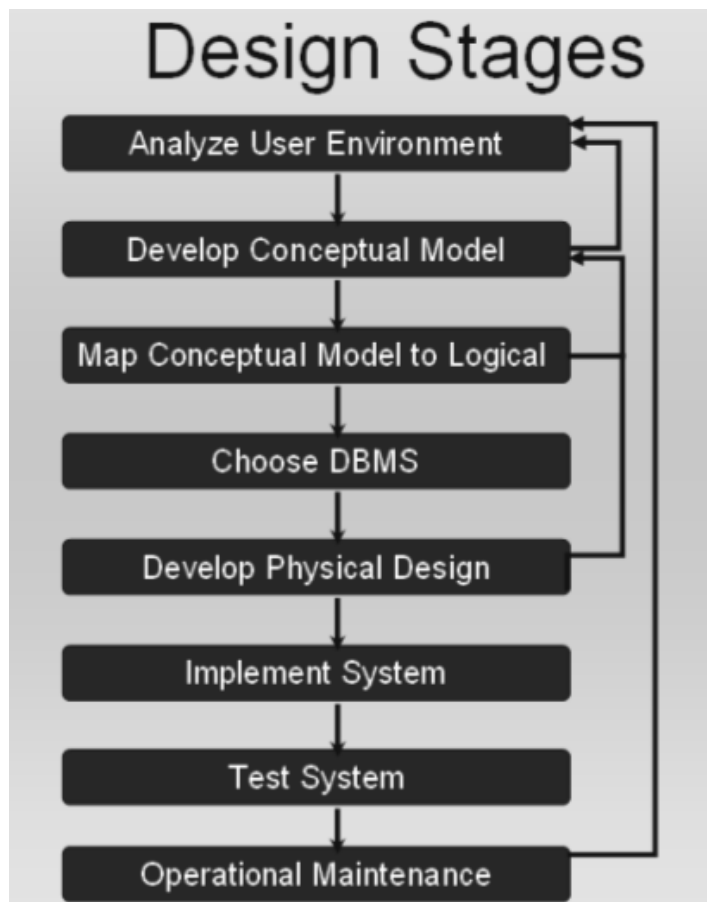

Fig: 3. Database Development Stages. (Second Approach)

- **Implement System**

This stage is also similar to the one described earlier, i.e., designing the application for different users and user groups of the organization.

- **Test System**

Testing is important in the sense that an application may be producing incorrect results, and this incorrectness may lead to the inconsistency of the system. So when a system

design is complete, once it is implemented it must be tested for proper operation and all the modules must be checked for their correctness. Whether the system modules are important or not because the result of the system is mostly dependent on the proper the functionality of all database applications and modules.

- **Operational Maintenance:**

Maintenance means to check that all parts of the system are working and once the testing of the system is completed the periodic maintenance measure are performed on the system to keep the system in working order.

Tools Used for Database System Development:

Why tools are used?

Tools are used for describing the design process in standard ways. If there is no standardized tool available for designing a specific systems; Then everyone will have to use its own design notation, and a notation used by one designer may not be understandable to the another one. This misunderstanding can be more drastic if both the designers are working for the development of the same system. Tools can also help the designer and the user to mutually agree on a specific design.

Data Flow Diagrams:

The most common tool used for deigning database systems is Data Flow Diagram. It is used to design systems graphically and expresses different system detail in different DFD levels.

DFDs show the flow of data between different processes o a specific system.

DFDs are simple, and hide complexities.

DFDs are Descriptive and links between processes describe the information flow.

- **Limitation of DFDs**

They do not provide us a way of expressing decision points.

DFDs are focused on flow of information only.

- **Symbols used in DFD:**

There are a limited number of symbols which are used for design process in DFDs.

- **DATAFLOW:**

The purpose of the dataflow in a DFD is to express the flow of information from one entity to another entity in the system

Data flows are pipelines through which packets of information flow.

Arrows are labeled with name of the data that moves through them. Figure-4 below show the Dataflow diagram



Fig: 4. Dataflow Symbol

- **DATA STORE:**

Data store is a repository for the storage of the data. When in a system the data is to be permanently stored somewhere for future reference or use the DATASTORE is used for this purpose. It is express with a rectangle open on right width and left width of the rectangle drawn with double lines.

Data in the DATASTORE is held sometimes for processing purposes also i-e it may not be a permanent data store.. Name of the DATASTORE is a noun which tells the storing location in the system. Or identifies the entity for which data is stored. Figure-5 shows a data store.



Fig: 5. Data store

- **Processes:**

Processes are expressed with ovals or rounded rectangles. Processes are used to express the transformation of incoming dataflow into outgoing dataflow. Process symbols are used for whatever is the action taking place and whatever is the magnitude or complexity of the action. Simply stating when data is transformed from one form into another the process symbol is used. Figure-6a and Figure-6b show two different shapes used for presenting process in DFD.

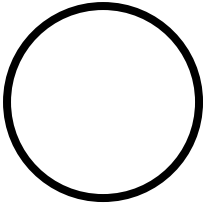

Fig: 6a

Process

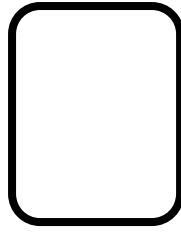

Fig-6b

- **DFD-Process:**

In DFD processes are numbered for expressing their existence at a certain level in the system.

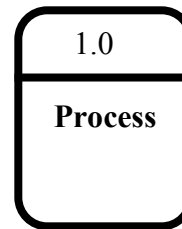
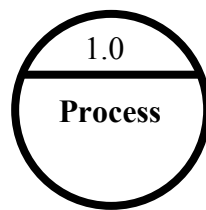

Fig: 7. Numbered DFD Processes

- **External Entities:**

These are the entities interacting with the system in any of two different ways. They may be either receiving the data from the system, or may be producing the data for the system to consume.

Shape used to express external entities is rectangle. The shape for external entity is shown in Figure-8.



Fig: 8. External Entity

- **Collector:**

This DFD shape is used to express several dataflow connections terminating at a single location. Collector is used to show the convergence of data to a single point. Fig 9a shows the Collector symbol and Fig 9b show a collector symbol acting as a sink for multiple data flows.

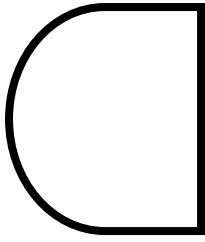

Fig: 9a Collector

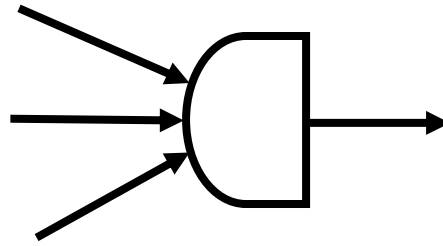

Fig 9b. Collector with Multiple Dataflow

- **Separator:**

The dataflow symbol which is used for separating data from a single source to multiple sinks is known as a separator.

Figure 10a show the presentation of separator and the figure 10b shows the separator as it may appear in a DFD.

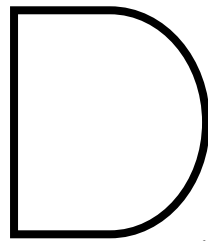

Fig: 10a Separator

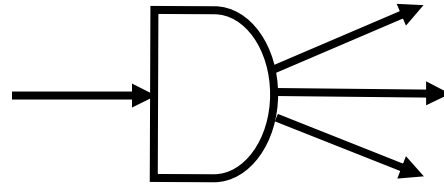

Fig 10b. Separator with Multiple Dataflow

- **Ring Sum Operator:**

This operator is used when data from a source process can flow to one of the mentioned sinks. For this purpose the symbol used is displayed in Figure: 11a and its presentation in a DFD is expressed in Figure-11b.

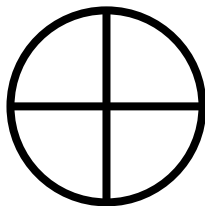

Fig: 11a Ring sum operator

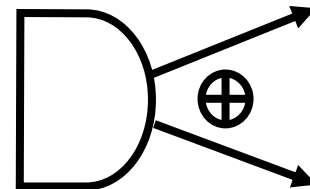

Fig 11b. Separator with Ring sum operator

- **AND Operator:**

This operator is used when data from a source process must flow to all the connected sinks. For this purpose the symbol used is displayed in Figure: 12a and its presentation in a DFD is expressed in Figure-12b.

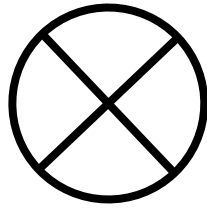

Fig: 12a AND operator

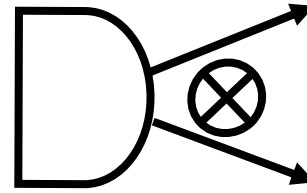

Fig 12b. Separator with AND operator

Types of DFD

- Context diagram
- Level 0 diagram
- Detailed diagram

- **Context Diagram:**

This is the level of DFD which provides the least amount of details about the working of the system. Context DFDs have the following properties:

They always consist of single process and describe the single system. The only process displayed in the CDFDs is the process/system being analyzed. Name of the CDFDs is generally a Noun Phrase.

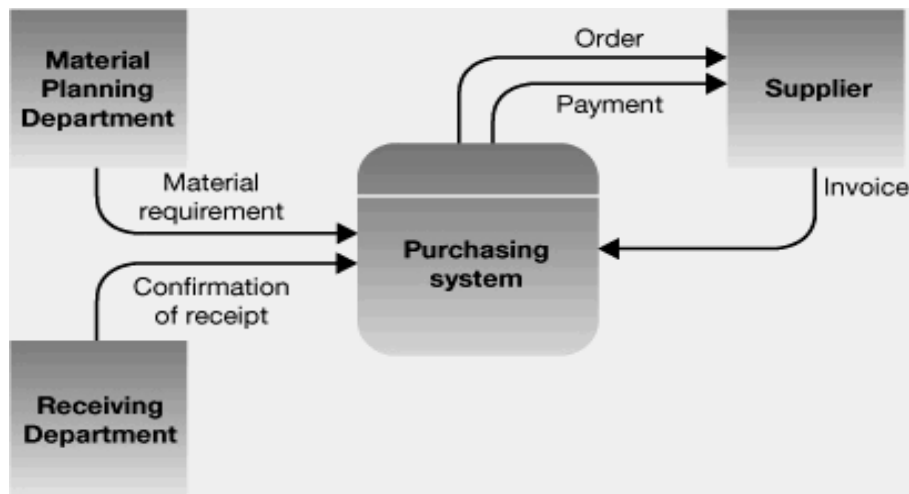

Fig: 13a. Example Context DFD Diagram

No System details are shown in the Contexts DFDs just context is shown. Input and output from and to the process are shown and interactions are shown only with the external entities. An example DFD at context level is shown in Figure: 13a and 13b.

In the context level DFDs no data stores are created. And dataflow from external entities are only directed toward the purported system and vice versa, no communication is shown between external entities themselves.

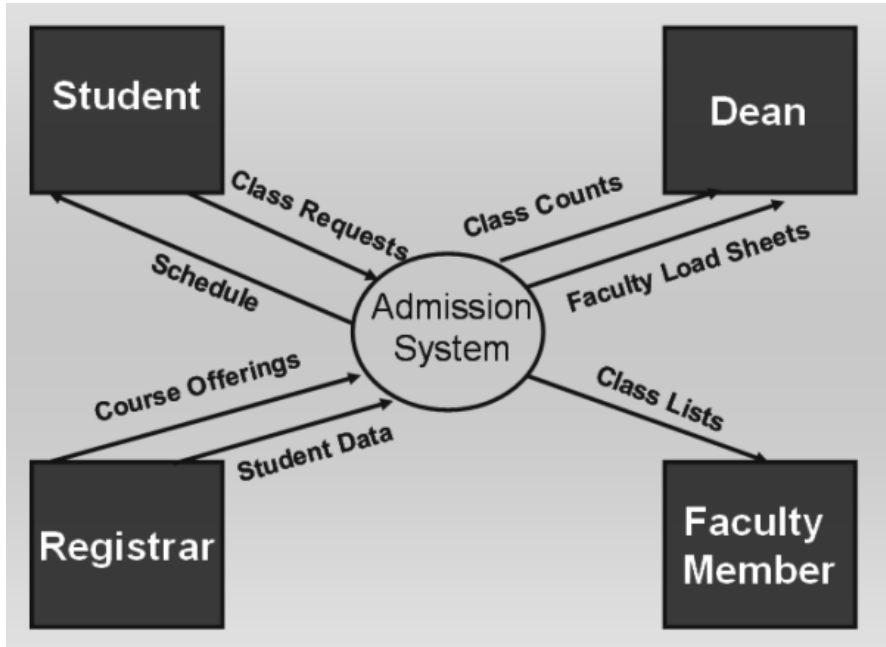

Fig: 13b. Example Context DFD Diagram

○ **Level 0 Data Flow Diagrams:**

The level 0 Diagram in the DFD is used to describe the working of the whole system. Once a context DFD has been created the level zero diagram or level ‘not’ diagram is created. The level zero diagram contains all the apparent details of the system. It shows the interaction between a numbers of processes and may include a large number of external entities. At this level it is the duty of the designer to keep a balance in describing the system using the level 0 diagram. Balance means that he should give proper depth to the level 0 diagram processes. Because placing too much details and showing all of the miniature processes in the level 0 diagrams makes it too much complex. On the other hand it is also not recommended to just ignore even larger processes of the system, because in such a case although the level 0 DFD will become simple but now we will have to create large number of detail DFDs. So a balance in describing the system should be kept so that the depth of the Level 0 DFD is manageable.

○ **Steps in creating the level 0 DFD**

1. Identify distinct modules of the system for which to create the DFD

2. Create DFDs for all the modules one by one to show the internal functionality of the system.
3. Once DFD for the distinct modules of the system have been created, establish link between different DFDs where required by either connecting the entities of the system, processes of the system or the data stores in different DFDs.
4. Now comes to the stage of placing the numbers on processes. As we know that the level 0 diagram encompasses a large number of smaller systems, and is a combination of a number of context DFDs. In level 0 diagram a process when it has a lot of details, it is not explained further in the level 0, and rather it is postponed for the detailed diagram. In the detailed Data Flow and is given a number. Numbering processes is based on a specific notation, in the level 0 diagrams only left half or the portion before the decimal point is valid but in the detailed diagram when a complex process is expressed further its sub processes are number like 1.0, 1.1, and 1.2 and so on.

Lecture No. 06

Reading Material

“Database Systems Principles, Design and Implementation” written by Catherine Ricardo, Maxwell Macmillan.	Section 2.4
-----------------------------------------------------------------------------------------------------------	-------------

Overview of Lecture

- Detailed DFD Diagrams:
- Database Design Phase
- Data Models
- Types of Data Models
- Types of Database Designs

Detailed Data Flow Diagram:

This Type of the Data flow diagrams is used when we have to further explain the functionality of the processes that we showed briefly in the Level 0 Diagram. It means that generally detailed DFDS are expressed as the successive details of those processes for which we do not or could not provide enough details.

The symbols and other rules regarding the detailed DFD are same as are in other types of DFDs. The special features associated with this diagram are that, one, it is optional, that is, it is created for only those processes from the level 0 diagram for which we want to show the details. For a small sized system we may not need to develop even a single detailed DFD, since the level 0 diagram might be covering it sufficiently. Second specific characteristic of the detailed DFD is its processes' numbering. Numbering of processes in the detailed DFD is done on the basis of numbering of the particular process in level 0 diagrams whose sub-processes are being included in the detailed DFD. For example, a specific process which was numbered in the level 0 diagram as 1.0 or 1 may have a number of sub-processes since we did not represent the process 1.0 in detail in level 0 diagrams. So in the detailed dataflow diagram we create sub-processes of that process and then number all the sub processes of that specific process as the sublets of the process.

Numbering of such sub processes is done as 1.1, 1.2, and 1.3... for first second and third sub-processes of the process 1.0 respectively. The phenomenon of creating sub-processes does not end at creating a few sub-processes for a specific process shown at level 0 diagrams. Rather it may continue deeper if there is requirement for further explanation of the any process or sub-processes. In such a case when we create sub-process of a sub-process 1.2 then the numbering is done in further extension of that specific sub processes number and example of such a numbering process is 1.2.1, 1.2.2, 1.2.3,...

Another point that is worth mentioning here is that we call processes in the detailed DFDs as sub-processes, but they are sub-processes only in reference to the process whose details they are explaining otherwise they are just like processes; transforming some input data into some form of output. The sub-processes may be performing relatively small amount of operations, still they are processes.

Maximum Number of Process in a DFD should not be very huge. Having a moderate number for a detailed DFD is also recommended because it adds clarity to our detailed data flow diagram. For clarity propose it is good to have a maximum of 7 or 9 processes in one detailed DFD. Moreover all the processes, sub processes, data stores, entities data flows and all other components of the DFD must be named properly, so that anyone who is using this DFD should be able to understand the DFD easily.

In all the levels of DFD it must be considered that all the processes have data inputs as well as data outputs. Data being sent to one process should be processed so that it changes its form and transforms from one form to another.

When creating a detailed diagram the data inputs and data outputs must be in coincidence, mean in both the diagrams the data input to a process and data output in the form of data flows must be same.

Data Dictionary

A database that containing data about all the databases in the database system. Data dictionaries store all the various schema and file specifications and their locations. They also contain information about which programs use which data and which users are interested in which reports.

Types of Data Dictionaries:

- **Integrated**

There are basically two types of data dictionaries which are available for use by a DBMS, with respect to their existence.

The first type of data dictionary in this context is the integrated data dictionary. Such a data dictionary is placed embedded into the database system, and is created by the DBMS for its usage under the directions and requirements provided by the DBA.

As the DBMS needs to talk with the “three level architecture” of database and mapping information along with all the database design information lies in the database schema. The DBMS uses the data dictionary to access the database at each layer or model, for this purpose the data dictionary of any type can be used but the integrated data dictionary is far more efficient than any free standing data dictionary because an integrated data dictionary is created by the DBMS itself and uses the same data accessing techniques etc.

- **Free Standing**

Second type of data dictionary is free standing data dictionary created by any CASE tool and then attached to the database management systems. A number of case tools are available for this purpose and help user designing the database and the database applications as well in some modern forms of the CASE tools.

Cross Reference Matrix

This is a tool available in the data dictionary and helps us in finding entities of the database and their associations. CRM is developed at the designing stage of the database; we can say that at the time of creation of the user views of reports for certain users we identify the material required by the users. In the cross reference matrix, on the Y axis we specify the accessible components of the database such as transitions, reports, or database objects and on the x axis we specify the attributes that will be accessed in the corresponding accessed object.

Now the matrix gets a shape of two dimensional arrays on which we have accessible objects of the database and on the other hand we have the elements which are available for access through those objects. Then whichever data item is accessible through a certain object we place a tick on the intersection of that row and column and thus we can easily identify the different items accessed in different reports.

	T r a n s c r i p t	S e m R e s C a r d	A t t e n d S h e e t	C l a s s R e s S u b	c C a s s R e s u l t
courseName	✓	✓		✓	
cumulative	✓	✓			✓
date	✓	✓		✓	✓
fatherName	✓	✓			
finalMarks				✓	
grade				✓	✓
grdPoint	✓	✓		✓	✓
marks	✓	✓			
midTerm				✓	
programName	✓	✓	✓	✓	✓
semesterCode	✓	✓			✓
semesterName	✓	✓	✓	✓	✓
semName			✓	✓	✓
session	✓	✓			
sessMarks				✓	
stName	✓	✓			
stNames			✓	✓	
stRegistrat	✓	✓			

Table 1: An example cross reference matrix

The cross reference matrix shown in table 1 lists different attributes against different reports required by different user groups of an exam system. Rows in this matrix contain different attributes and the columns contain different reports. Now the tick mark in the cells represents the use or presence of attributes in different reports. This matrix represents, on one side, the relative importance or use of different attributes. On the other hand it also helps to identify different entity types and their defining attributes. The attributes that are represented collectively on one or more reports are candidates of combining into a single entity type. Although it is necessary that attributes appearing together should be grouped into same entity type, but still they are candidates for combining into the one.

Data Dictionary is not very necessary for using such a cross reference matrix, instead for relatively small systems it can be created manually.

Outcome of the Analysis Phase

In the preliminary study phase, database designers collect information about the existing system from the users of the system. For this purpose they may interview different users or concerned persons, or they may distribute questionnaires among different users and ask them to fill them in and later may use these questionnaires in the analysis phase. Designers represent their understanding of the working of existing system in the form of DFDs and discuss it with the users to make it sure that they have understood all details of the existing system and the requirements of different users groups.

The DFDs are input to the analysis phase, where designers analyze the requirements of the users and establish the procedure to meet those requirements. From the database perspective, in the analysis phase designers have to identify the facts or data that is required to be stored in order to fulfill the users' requirements. For this purpose they may use some CASE tools, like cross reference matrix. Generally, in the analysis phase, designers prepare a draft or initial database design that they ultimately finalize in the next phase, that is, the database design phase. So in short we can say, that DFDs are the output of the preliminary phase and are input to the analysis phase. The initial design or a draft form of design (generally in entity-relationship data model) is the output of the analysis phase and input to the design phase. In the design phase, then you finalize the design.

The sequence of the activities mentioned above is not much important, however, the activities mentioned are important and must be performed in order to have a correct database or database application design. In the following lectures, we are going to study different tools that are used in the design phase, that is, the data models. We will be studying, both, the data models and their implementation in the database design phase.

Database Design Phase

Database design phase follows the analysis phase. Before starting the discussion on the design activity, it will be wise if we clearly understand some basic concepts that are frequently used in this phase.

- **Database Design /Database Model**

These terms can be used interchangeably for the logical structure of the database. The database design/model stores the structure of the data and the links/relationships between data that should be stored to meet the users' requirements. Database design is stored in the database schema, which is in turn stored in the data dictionary.

- **Database Modeling**

The process of creating the logical structure of the database is called database modeling. It is a very important process because the designing of the application provides us the basis for running our database system. If the database is not designed properly the implementation of the system can not be done properly. Generally the design of the database is represented graphically because it provides an ease in design and adds flexibility for the understanding of the system easily.

Data Model

Data model is a set or collection of construct used for creating a database and producing designs for the databases. There are a few components of a data model:

- **Structure:**

What structures can be used to store the data is identified by the structures provided by the data model structures.

- **Manipulation Language**

For using a certain model certain data manipulations are performed using a specific language. This specific language is called data manipulation language.

- **Integrity Constraints**

These are the rules which ensure the correctness of data in the database and maintain the database in usable state so that correct information is portrayed in designing the database. Generally these components are not explicitly defined in data models, they may be available in some of the modern DBMSs but in traditional and general model, these may not be available.

Significance of the Data Model

Data model is very important tool because it is something which is sued for designing the database for a DBMS and no DBMS can exist independent of any data model, now if we use a specific DBMS but are not sure about the data model it uses for data abase usage, we can not create a proper database.

As a specific DBMS is base on the use of a specific data model so when using a DBMS it is of great use to know that what structures, manipulation languages and integrity constraints are implemented by a specific DBMS. As it is the only way to know the facilities and functionalities offered by the DBMS.

This is the reason whenever we get a specific DBMS, it is explicitly mentioned with that DBMS, that which data model this DBMS uses.

Types of Data Models

- **Semantic Data Model**

These are the data models which provide us better flexibility in implementing constraints, better language utilities and better data structure constructs. As a result actions performed using proper data and structure tools gives us better data designing and manipulation facilities. A better data model provides better opportunities to express multiple situations in the database design and as a result get better output from the tool or model in the form of a better database design.

- ER- Data Model
- Object oriented data model

- Record Based Data Model

This is the second type of data models available to use and has three basic types

- Hierarchical Data Model
- Network Data model
- Relational Data model

These models are records based and are not in similarity with those of semantic data models. These models handle the data at almost all the three level of the three layers of the database architecture. Semantic data models are generally used for designing the logical or conceptual model of the database system, once very common example of the semantic data model is ER-Data Model and is very much popular for designing databases. No DBMS is based on ER Data model because it is purely used for designing whereas a number of DBMS are available based on OO data model, network data model, relational data model and hierarchical data model.

Types of Database Design

Conceptual database design

This design is implemented using a semantic data model, for example for creating a design for an organization database we can use and we do use the ER-Data model.

Logical Database design

This design is performed using a data model for which we have a DBMS available and we are planning to run our database system that DBMS.

Physical Database Design:

The Logical design created using a specific data model and created after the analysis of the organization, it needs to be implemented in a physical DBMS software so the Physical database design is performed and the design created so far in the logical form are implemented on that very DBMS.

By separating the three design levels we get the benefit of abstraction on one hand whereas on the other hand we can create our logical and conceptual designs using better design tools, which would have not been possible if we are using the same design-tool for all the three levels. Moreover if in future there is a need to make a change in the physical implementation of the data we will have to make no changes in the logical or conceptual level of the database design , rather the change can be achieved by only using the existing conceptual model and implementing it again on Physical model using a separate DBMS.

Lecture No. 07

Reading Material

“Database Systems Principles, Design and Implementation” written by Catherine Ricardo, Maxwell Macmillan.	Section: 5.2 5.3
Hoffer	Page: 85 - 95

Overview of Lecture

- Entity
- Different types of Entities
- Attribute and its different types
- In the previous lecture we discussed the importance and need of data models. From this lecture we are going to start detailed discussion on a data model, which is the entity relationship data model also known as E-R data model.

Entity-Relationship Data Model

It is a semantic data model that is used for the graphical representation of the conceptual database design. We have discussed in the previous lecture that semantic data models provide more constructs that is why a database design in a semantic data model can contain/represent more details. With a semantic data model, it becomes easier to design the database, at the first place, and secondly it is easier to understand later. We also know that conceptual database is our first comprehensive design. It is independent of any particular implementation of the database, that is, the conceptual database design expressed in E-R data model can be implemented using any DBMS. For that we will have to transform the conceptual database design from E-R data model to the data model of the particular DBMS. There is no DBMS based on the E-R data model, so we have to transform the conceptual database design anyway.

A question arises from the discussion in the previous paragraph, can we avoid this transformation process by designing our database directly using the data model of our selected DBMS. The answer is, yes we can but we do not do it, because most commercial DBMS are based on the record-based data models, like Hierarchical, Network or Relational. These data models do not provide too much constructs, so a database design

in these data models is not so expressive. Conceptual database design acts as a reference for many different purposes. Developing it in a semantic data model makes it much more expressive and easier to understand, that is why we first develop our conceptual database design in E-R data model and then later transform it into the data model of our DBMS.

Constructs in E-R Data Model

The E-R data model supports following major constructs:

- Entity
- Attribute
- Relationship

We are going to discuss each one of them in detail.

The Entity

Entity is basic building block of the E-R data model. The term entity is used in three different meanings or for three different terms and that are:

- Entity type
- Entity instance
- Entity set

In this course we will be using the precise term most of the time. However after knowing the meanings of these three terms it will not be difficult to judge from the context which particular meaning the term entity is being used in.

Entity Type

The entity type can be defined as a name/label assigned to items/objects that exist in an environment and that have similar properties. It could be person, place, event or even concept, that is, an entity type can be defined for physical as well as not-physical things. An entity type is distinguishable from other entity types on the basis of properties and the same thing provides the basis for the identification of an entity type. We analyze the things existing in any environment or place. We can identify or associate certain properties with each of the existing in that environment. Now the things that have common or similar properties are candidates of belonging to same group, if we assign a name to that group then we say that we have identified an entity type.

Generally, the entity types and their distinguishing properties are established by nature, by very existence of the things. For example, a bulb is an electric accessory, a cricket bat is a sports item, a computer is an electronic device, a shirt is a clothing item etc. So identification of entity types is guided by very nature of the things and then items having properties associated with an entity type are considered to be belonging to that entity type or instances of that entity type. However, many times the grouping of things in an environment is dictated by the specific interest of the organization or system that may supersede the natural classification of entity types. For example, in an organization, entity

types may be identified as donated items, purchased items, manufactured items; then the items of varying nature may belong to these entity types, like air conditioners, tables, frying pan, shoes, car; all these items are quite different from each other by their respective nature, still they may be considered the instances of the same entity type since they are all donated or purchased or manufactured.

What particular properties of an entity type should be considered or which particular properties jointly form an entity type? The answer to this question we have discussed in detail in our very first lecture, where we were discussing the definition of database. That is, the perspective or point of view of the organization and the system for which we are developing the database is going to guide us about the properties of interest for a particular group of things. For example, if you have a look around you in your bedroom, you might see tube light, a bulb, fan, air conditioner, carpet, bed, chair and other things. Now fan is an item that exists in your room, what properties of the fan we are interest in, because there could be so many different properties of the fan. If we are developing the database for a manufacturer, then we may be interested in type of material used for wings, then the thickness of the copper wire in the coil, is it locally manufactured or bought ready made, what individual item costs, what is the labor cost, what is the total cost, overhead, profit margin, net price etc. But if we are working for a shopkeeper he might be interested in the name of the company, dealer price, retail price, weight, color of fan etc. From the user perspective; company name, color, price, warranty, name of the dealer, purchase date and alike. So the perspective helps/guides the designer to associate or identify properties of things in an environment.

The process of identifying entity types, their properties and relationships between them is called abstraction. The abstraction process is also supported by the requirements gathered during initial study phase. For example, the external entities that we use in the DFDs provide us a platform to identify/locate the entity types from. Similarly, if we have created different cross reference matrices, they help us to identify different properties of the things that are of interest in this particular system and that we should the data about. Anyway, entity types are identified through abstraction process, then the items possessing the properties associated with a particular entity type are said to be belonging to that entity type or instances of that entity type.

While designing a system, you will find that most of the entity types are same as are the external entities that you identified for the DFDs. Sometimes they may be exactly the same. Technically, there is a minor difference between the two and that is evident from their definitions. Anything that receives or generates data from or to the system is an external entity, where as entity type is name assigned to a collection of properties of different things existing in an environment. Anything that receives or generates data is considered as external entity and is represented in the DFD, even if it is a single thing. On the other hand, things with a single instance are assumed to be on hand in the environment and they are not explicitly identified as entity type, so they are not represented in the E-R diagram. For example, a librarian is a single instance in a library system, (s)he plays certain role in the library system and at many places data is generated

from or to the librarian, so it will be represented at relevant places in the DFDs. But the librarian will not be explicitly represented in the E-R diagram of the library system and its existence or role is assumed to be there and generally it is hard-coded in the application programs.

Entity Instance

A particular object belonging to a particular entity type and how does an item becomes an instance of or belongs to an entity type? By possessing the defining properties associated with an entity type. For example, following table lists the entity types and their defining properties:

Entity Types	Properties	Instances
EMPLOYEE	Human being, has name, has father name, has a registration number, has qualification, designation	M. Sharif, Sh. Akmal and many others
FURNITURE	Used to sit or work on, different material, having legs, cost, purchased	Chair, table etc.
ELECTRIC APPLIANCES	Need electricity to work, purchased	Bulb, fan, AC
OFFICE EQUIPMENT	Used for office work, consumable or non-consumable,	Papers, pencil, paper weight etc.

Table 1: Entity types, their properties and instances

Each entity instance possesses certain values against the properties with the entity type to which it belongs. For example, in the above table we have identified that entity type EMPLOYEE has name, father name, registration number, qualification, designation. Now an instance of this entity type will have values against each of these properties, like (M. Sajjad, Abdul Rehman, EN-14289, BCS, and Programmer) may be one instance of entity type EMPLOYEE. There could be many others.

Entity Set

A group of entity instances of a particular entity type is called an entity set. For example, all employees of an organization form an entity set. Like all students, all courses, all of them form entity set of different entity types

As has been mentioned before that the term entity is used for all of the three terms mentioned above, and it is not wrong. Most of the time it is used to mention an entity type, next it is used for an entity instance and least times for entity set. We will be precise most of the time, but if otherwise you can judge the particular meaning from the context.

Classification of entity types

Entity types (ETs) can be classified into regular ETs or weak ETs. Regular ETs are also called strong or independent ETs, whereas weak ETs are also called dependent ETs. In the following we discuss them in detail.

Weak Entity Types

An entity type whose instances cannot exist without being linked with instances of some other entity type, i.e., they cannot exist independently. For example, in an organization we want to maintain data about the vehicles owned by the employees. Now a particular vehicle can exist in this organization only if the owner already exists there as employee. Similarly, if employee leaves the job and the organization decides to delete the record of the employee then the record of the vehicle will also be deleted since it cannot exist without being linked to an instance of employee.

Strong Entity Type

An entity type whose instances can exist independently, that is, without being linked to the instances of any other entity type is called strong entity type. A major property of the strong entity types is that they have their own identification, which is not always the case with weak entity types. For example, employee in the previous example is an independent or strong entity type, since its instances can exist independently.

Naming Entity Types

Following are some recommendations for naming entity types. But they are just recommendations; practices considered good in general. If one, some or all of them are ignored in a design, the design will still be valid if it satisfies the requirements otherwise, but good designs usually follow these practices:

- Singular noun recommended, but still plurals can also be used
- Organization specific names, like customer, client, gahak anything will work
- Write in capitals, yes, this is something that is generally followed, otherwise will also work.
- Abbreviations can be used, be consistent. Avoid using confusing abbreviations, if they are confusing for others today, tomorrow they will confuse you too.

Symbols for Entity Types

A rectangle is used to represent an entity type in E-R data model. For strong entity types rectangle with a single line is used whereas double lined rectangle is drawn to represent a weak entity type as is shown below:

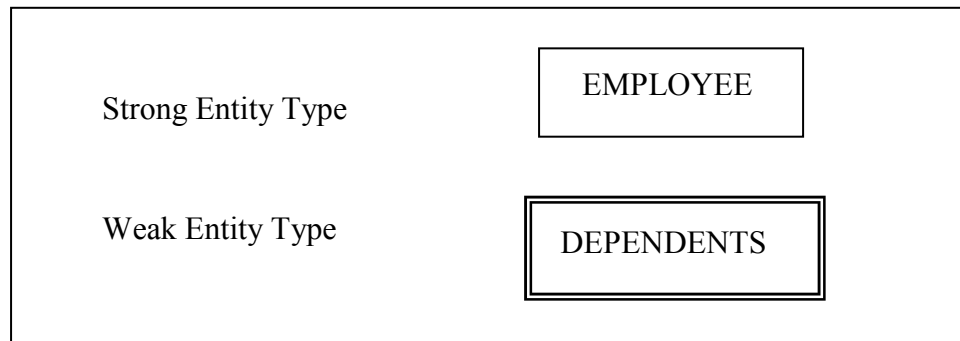

Figure 1: Symbols used for entity types

We have discussed different types of entity types; in the next section we are going to discuss another component of E-R data model, that is, the attribute.

Attribute

An attribute of an entity type is a defining property or quality of the instances of that entity type. Entity instances of same entity type have the same attributes. (E.g. Student Identification, Student Name). However, values of these attributes may be same or different. For example, all instances of the entity type STUDENT may have the attributes name, father name, age; but the values against each of these attributes for each instance may be different. Like, one instance may have the values (M. Hafeez, Noor Muhammad, 37) other may have others. Remember one thing, that the values of the attributes may be same among different entity instances. The thing to remember at this stage is that attributes are associated with an entity type and those attributes then become applicable /valid for all the instances of that entity type and instances have values against these attributes.

An attribute is identified by a name allocated to it and that has to be unique with respect to that entity type. It means one entity type cannot have two attributes with the same name. However, different entity types may have attributes with the same name. The guidelines for naming an attribute are similar to those of entity types. However, one difference is regarding writing the names of attributes. The notation that has been adopted in this course is that attribute name generally consists of two parts. The name is started in lower case, and usually consists of abbreviation of the entity types to which the attribute belongs. Second part of the attribute name describes the purpose of attribute and only first letter is capitalized. For example empName means name attribute of entity type EMPLOYEE, stAdrs means address attribute of the entity type STUDENT and alike. Others follow other notations, there is no restriction as such, and you can follow anyone that you feel convenient with. BUT be consistent.

Domain of an Attribute

We have discussed in the previous section that every attribute has got a name. Next thing is that a domain is also associated with an attribute. These two things, name and the domain, are part of the definitions of an attribute and we must provide them. Domain is the set of possible values that an attribute can have, that is, we specify a set of values either in the form of a range or some discrete values, and then attribute can have value out of those values. Domain is a form of a check or a constraint on attribute that it cannot have a value outside this set.

Associating domain with an attribute helps in maintaining the integrity of the database, since only legal values could be assigned to an attribute. Legal values mean the values that an attribute can have in an environment or system. For example, if we define a salary attribute of EMPLOYEE entity type to hold the salary of employees, the value assigned to this attribute should be numeric, it should not be assigned a value like 'Reema', or '10/10/2004', why, because they are not legal salary values¹. It should be numeric. Further, even if we have declared it as numeric it will have numeric values, but about a value like 10000000000. This is a numeric value, but is it a legal salary value within an organization? You have to ask them. It means not only you will specify that the value of salary will be numeric but also associate a range, a lower and upper limit. It reduces the chances of mistake.

Domain is normally defined in form of data type and some additional constraints like the range constraint. Data type is defined as a set of values along with the operations that can be performed on those values. Some common data types are Integer, Float, Varchar, Char, String, etc. So domain associates certain possible values with an attribute and certain operations that can be performed on the values of the attribute. Another important thing that needs to be mentioned here is that once we associate a domain to an attribute, all the attributes in all entity instances of that entity type will have the values from the same domain. For example, it is not possible that in one entity instance the attribute salary has a value 15325.45 and in another instance the same attribute has a value 'Reema'. No. All attribute will have values from same domain, values may be different or same, whatever, but the domain will be the same.

¹ Sometimes when some coding has been adopted, then such strange values may be legal but here we are discussing the general conditions

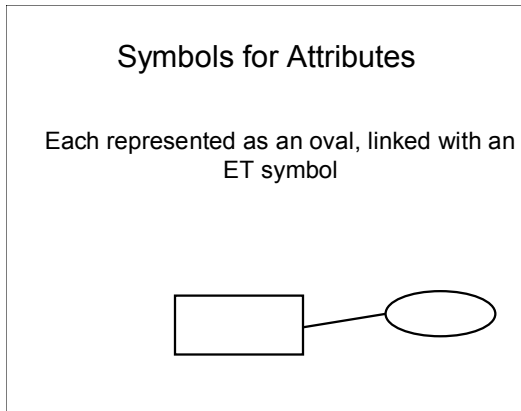

Figure 2: Symbol used for attribute in E-R diagram

Types of Attributes

Attributes may be of different types. They may be:

- Simple or Composite
- Single valued or multi-valued
- Stored or Derived

Simple or Composite Attributes:

An attribute that is a single whole is a simple attribute. The value of a simple attribute is considered as a whole, not as comprising of other attributes or components. For example, attributes `stName`, `stFatherName`, `stDateOfBorth` of an entity type `STUDENT` are example of simple attributes. On the other hand if an attribute consists of collection of other simple or composite attributes then it is called a composite attributes. For example, `stAdres` attribute may comprise of `houseNo`, `streetNo`, `areaCode`, `city` etc. In this case `stAdres` will be a composite attribute.

Single valued or multi-valued Attributes:

Some attribute have single value at a time, whereas some others may have multiple values. For example, hobby attribute of `STUDENT` or skills attribute of `EMPLOYEE`, since a student may have multiple hobbies, likewise an employee may have multiple skills so they are multi-valued attributes. On the other hand, name, father name, designation are generally single valued attributes.

Stored or Derived Attributes:

Normally attributes are stored attributes, that is, their values are stored and accessed as such from the database. However, sometimes attributes' values are not stored as such, rather they are computed or derived based on some other value. This other value may be stored in the database or obtained some other way. For example, we may store the name, father name, address of employees, but age can be computed from date of birth. The

advantage of declaring age as derived attribute is that whenever we will access the age, we will get the accurate, current age of employee since it will be computed right at the time when it is being accessed.

How a particular attribute is stored or defined, it is decided first by the environment and then it has to be designer's decision; your decision. Because, the organization or system will not object rather they will not even know the form in which you have defined an attribute. You have to make sure that the system works properly, it fulfills the requirement; after that you do it as per your convenience and in an efficient way.

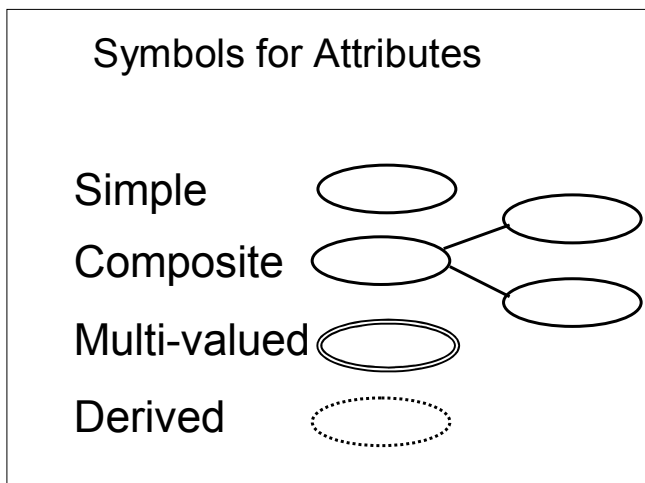

Figure 3: Symbol used for different types of attributes in E-R diagram

An example diagram representing all types of attributes is given below:

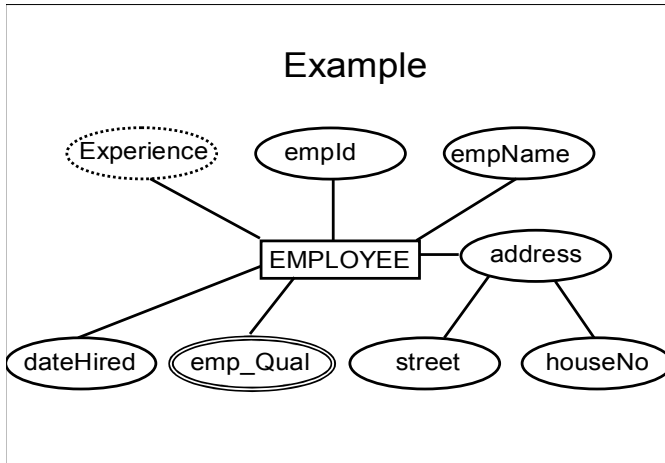

Figure 4: Example entity type with attributes of different types
This concludes this lecture.

Summary:

In this lecture we have discussed entity and attribute. We discussed that there are three different notions for which the term entity is used and we looked into these three terms in detail. They are entity type, entity instance and entity set. An entity type is name or label assigned to items or objects existing in an environment and having same or similar property. An entity instance is a particular item or instance that belongs to a particular entity type and a collection of entity instances is called an entity set. We also discussed in this lecture the attribute component of the E-R data model and its different types. The third component the E-R data model, that is, the relationship will be discussed in the next lecture.

Exercises:

- Take a look into the system where you work or study or live, identify different entity types in that environment. Associate different types of attributes with these entity types.
- Look at the same environment from different possible perspectives and realize the difference that the change of perspective makes in the abstraction process that results in establishing different entity types or/and their different properties.

Lecture No. 08

Reading Material

“Database Systems Principles, Design and Implementation” written by Catherine Ricardo, Maxwell Macmillan.	Section 5.4
--------------------------------------------------------------------------------------------------------------	-------------

Overview of Lecture

- Concept of Key and its importance
- Different types of keys

Attributes

Def 1:

An attribute is any detail that serves to identify, qualify, classify, quantify, or otherwise express the state of an entity occurrence or a relationship.

Def 2:

Attributes are data objects that either identify or describe entities.

Identifying entity type and then assigning attributes or other way round; it's an “egg or hen” first problem. It works both ways; differently for different people. It is possible that we first identify an entity type, and then we describe it in real terms, or through its attributes keeping in view the requirements of different users' groups. Or, it could be other way round; we enlist the attribute included in different users' requirements and then group different attributes to establish entity types. Attributes are specific pieces of information, which need to be known or held. An attribute is either required or optional. When it's required, we must have a value for it, a value must be known for each entity occurrence. When it's optional, we could have a value for it, a value may be known for each entity occurrence.

The Keys

Attributes act as differentiating agents among different entity types, that is, the differences between entity types must be expressed in terms of attributes. An entity type can have many instances; each instance has got a certain value against each attribute defined as part of that particular entity type. A *key* is a set of attributes that can be used to

identify or access a particular entity instance of an entity type (or out of an entity set). The concept of key is beautiful and very useful; why and how. An entity type may have many instances, from a few to several thousands and even more. Now out of many instances, when and if we want to pick a particular/single instance, and many times we do need it, then key is the solution. For example, think of whole population of Pakistan, the data of all Pakistanis lying at one place, say with NADRA people. Now if at sometime we need to identify a particular person out of all this data, how can we do that? Can we use name for that, well think of any name, like Mirza Zahir Iman Afroz, now we may find many people with this name in Pakistan. Another option is the combination of name and father name, then again, Amjad Malik s/o Mirza Zahir Iman Afroz, there could be so many such pairs. There could be many such examples. However, if you think about National ID Card number, then no matter whatever is the population of Pakistan, you will always be able to pick precisely a single person. That is the key. While defining an entity type we also generally define the key of that entity type. How do we select the key, from the study of the real-world system; key attribute(s) already exist there, sometimes they don't then the designer has to define one. A key can be simple, that is, consisting of single attribute, or it could be composite which consists of two or more attributes. Following are the major types of keys:

- Super Key
- Candidate Key
- Primary Key
- Alternate Key
- Secondary Key
- Foreign Key

The last one will be discussed later, remaining 5 are discussed in the following:

- **Super key**
A **super key** is a set of one or more attributes which taken collectively, allow us to identify uniquely an entity instance in the entity set. This definition is same as of a key, it means that the super key is the most general type of key. For example, consider the entity type STUDENT with attributes registration number, name, father name, address, phone, class, admission date. Now which attribute can we use that can uniquely identify any instance of STUDENT entity type. Of course, none of the name, father name, address, phone number, class, admission date can be used for this purpose. Why? Because if we consider name as super key, and situation arises that we need to contact the parents of a particular student. Now if we say to our registration department that give us the phone number of the student whose name is Ilyas Hussain, the registration department conducts a search and comes up with 10 different Ilyas Hussain, could be anyone. So the value of the name attribute cannot be used to pick a particular instance. Same happens with other attributes. However, if we use the registration number, then it is 100% sure that with a particular value of registration number we will always find exactly a single unique entity instance. Once you identified the instance, you have all its attributes available, name, father name,

everything. The entity type STUDENT and its attributes are shown graphically in the figure 1 below, with its super key “regNo” underlined.

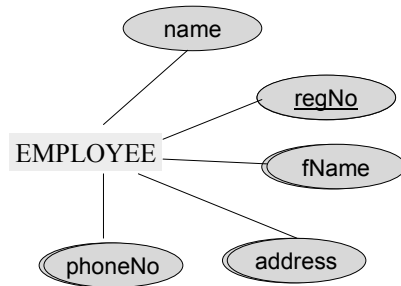

Fig. 1: An entity type, its defining attributes and super key (underlined)

Once specific characteristic with super key is that, as per its definition any combination of attributes with the super key is also a super key. Like, in the example just discussed where we have identified regNo as super key, now if we consider any combination of regNo with any other attribute of STUDENT entity type, the combination will also be a super key. For example, “regNo, name”, “regNo, fName, address”, “name, fName, regNo” and many others, all are super keys.

○ **Candidate key**

A super key for which no subset is a super key is called a candidate key, or the minimal super key is the candidate key. It means that there are two conditions for the candidate key, one, it identifies the entity instances uniquely, as is required in case of super key, second, it should be minimum, that is, no proper subset of candidate key is a key. So if we have a simple super key, that is, that consists of single attribute, it is definitely a candidate key, 100%. However, if we have a composite super key and if we take any attribute out of it and remaining part is not a super key anymore then that composite super key is also a candidate key since it is minimal super key. For example, one of the super keys that we identified from the entity type STUDENT of figure 1 is “regNo, name”, this super key is not a candidate key, since if we remove the regNo attribute from this combination, name attribute alone is not able to identify the entity instances uniquely, so it does not satisfy the first condition of candidate key. On the other hand if we remove the attribute name from this composite key then the regNo alone is sufficient to identify the instances uniquely, so “regNo, name” does have a proper subset (regNo) that can act as a super key; violation of second condition. So the composite key “regNo, name” is a super key but it is not a candidate key. From here we can also establish a fact that every candidate key is a super key but not the other way round.

○ **Primary Key**

A candidate key chosen by the database designer to act as key is the primary key. An entity type may have more than one candidate keys, in that case the database designer has

to designate one of them as primary key, since there is always only a single primary key in an entity type. If there is just one candidate key then obviously the same will be declared as primary key. The primary key can also be defined as the successful candidate key. Figure 2 below contains the entity type STUDENT of figure 1 but with an additional attribute nIdNumber (national ID card Number).

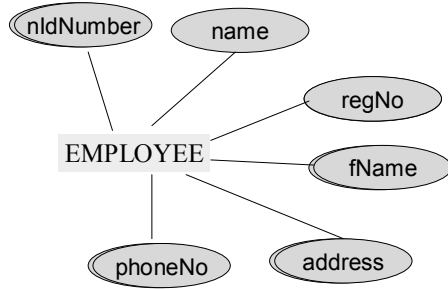

Fig. 2: An entity type, its defining attributes and two candidate keys

In figure 2, we can identify two different attributes that can individually identify the entity instances of STUDENT and they are regNo and nIdNumber, both are minimal super keys so both are candidate keys. Now in this situation we have got two candidate keys. The one that we choose will be declared as primary key, other will be the alternate key. Any of the candidate keys can be selected as primary key, it mainly depends on the database designer which choice he/she makes. There are certain things that are generally considered while making this decision, like the candidate key that is shorter, easier to remember, to type and is more meaningful is selected as primary key. These are general recommendations in this regard, but finally it is the decision of the designer and he/she may have his/her own reasons for a particular selection that may be entirely different from those mentioned above. The relation that holds between super and candidate keys also holds between candidate and primary keys, that is, every primary key (PK) is a candidate key and every candidate key is a super key.

A certain value that may be associated with any attribute is NULL, that means “not given” or “not defined”. A major characteristic of the PK is that it cannot have the NULL value. If PK is a composite, then none of the attributes included in the PK can have the NULL, for example, if we are using “name, fName” as PK of entity type STUDENT, then none of the instances may have NULL value in either of the name or fName or both.

○ **Alternate Keys**

Candidate keys which are not chosen as the primary key are known as alternate keys. For example, we have two candidate keys of STUDENT in figure 2, *regNo* and *nIdNumber*, if we select *regNo* as PK then the *nIdNumber* will be alternate key.

○ **Secondary Key**

Many times we need to access certain instances of an entity type using the value(s) of one or more attributes other than the PK. The difference in accessing instances using the

value of a key or non-key attribute is that the search on the value of PK will always return a single instance (if it exists), where as uniqueness is not guaranteed in case of non-key attribute. Such attributes on which we need to access the instances of an entity type that may not necessarily return unique instance is called the secondary key. For example, we want to see how many of our students belong to Multan, in that case we will access those instances of the STUDENT entity type that contain “Multan” in their address. In this case address will be called secondary key, since we are accessing instances on the basis of its value, and there is no compulsion that we will get a single instance. Keep one thing in mind here, that a particular access on the value of a secondary key MAY return a single instance, but that will be considered as chance or due to that particular state of entity set. There is not the compulsion or it is not necessary for secondary key to return unique instance, where as in case of super, candidate, primary and alternate keys it is compulsion that they will always return unique instance against a particular value.

Summary

Keys are fundamental to the concept almost any data model including the E-R data model because they enable the unique identity of an entity instance. There are different type of keys that may exist in an entity type.

Exercises:

- Define attributes of the entity types CAR, BOOK, MOVIE; draw them graphically
- Identify different types of keys in each one of them

Lecture No. 09

Reading Material

“Database Systems Principles, Design and Implementation” written by Catherine Ricardo, Maxwell Macmillan.	
--------------------------------------------------------------------------------------------------------------	--

Overview of Lecture

- Relationships in E-R Data Model
- Types of Relationships

Relationships

After two or more entities are identified and defined with attributes, the participants determine if a *relationship* exists between the entities. A relationship is any association, linkage, or connection between the entities of interest to the business; it is a two-directional, significant association between two entities, or between an entity and itself. Each relationship has a name, an optionality (*optional* or *mandatory*), and a degree (how many). A relationship is described in real terms.

Assigning a name, optionality, and a degree to a relationship helps confirm the validity of that relationship. If you cannot give a relationship all these things, then perhaps there really is no relationship at all.

Relationship represents an association between two or more entities. An example of a relationship would be:

- Employees are assigned to projects
- Projects have subtasks
- Departments manage one or more projects

Relationships are the *connections and interactions* between the entities instances e.g. DEPT_EMP associates Department and Employee.

- A ***relationship type*** is an abstraction of a relationship i.e. a set of relationships instances sharing common attributes.

- Entities enrolled in a relationship are called its *participants*.

The participation of an entity in a relationship is *total* when all entities of that set might be participant in the relationship otherwise it is *partial* e.g. if every *Part* is supplied by a *Supplier* then the SUPP_PART relationship is total. If certain parts are available without a supplier than it is partial.

Naming Relationships:

If there is no proper name of the association in the system then participants' names or abbreviations are used. STUDENT and CLASS have ENROLL relationship. However, it can also be named as STD_CLS.

Roles:

Entity set of a relationship need not be distinct. For example

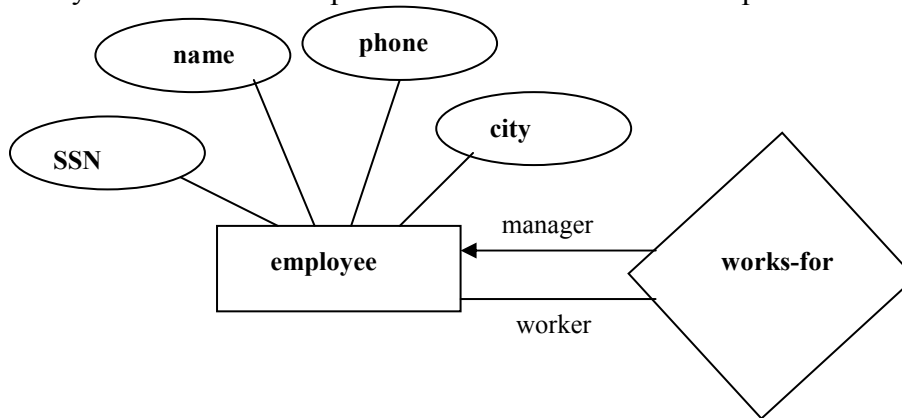

The labels “manager” and “worker” are called “roles”. They specify how employee entities interact via the “works-for” relationship set. Roles are indicated in ER diagrams by labeling the lines that connect diamonds to rectangles. Roles are optional. They clarify semantics of a relationship.

Symbol for Relationships:

- Shown as a Diamond
- Diamond is doubled if one of the participant is dependent on the other
- Participants are connected by continuous lines, labeled to indicate cardinality.
- In partial relationships roles (if identifiable) are written on the line connecting the partially participating entity rectangle to the relationship diamond.
- Total participation is indicated by double lines

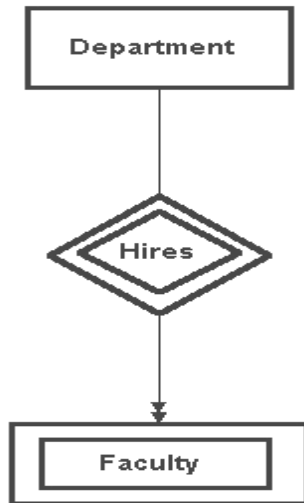

Types of Relationships

- **Unary Relationship**

An ENTITY TYPE linked with itself, also called recursive relationship. Example Roommate, where STUDENT is linked with STUDENT

Example 1:

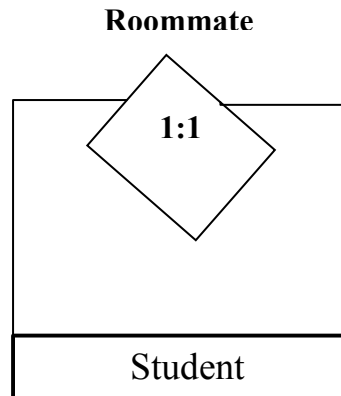

**Example
2:**

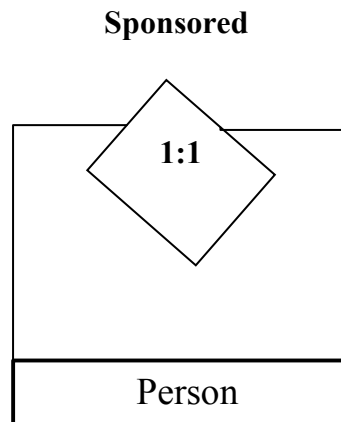

○ **Binary relationship**

A **Binary** relationship is the one that links two entities sets e.g. **STUDENT-CLASS**. Relationships can be formally described in an ordered pair form.

Enroll = {(S1001, ART103A), (S1020, CS201A), (S1002, CSC201A)}

Entire set is relationship set and each ordered pair is an instance of the relationship.



○ **Ternary Relationship**

A **Ternary** relationship is the one that involves three entities e.g. **STUDENT-CLASS-FACULTY**.

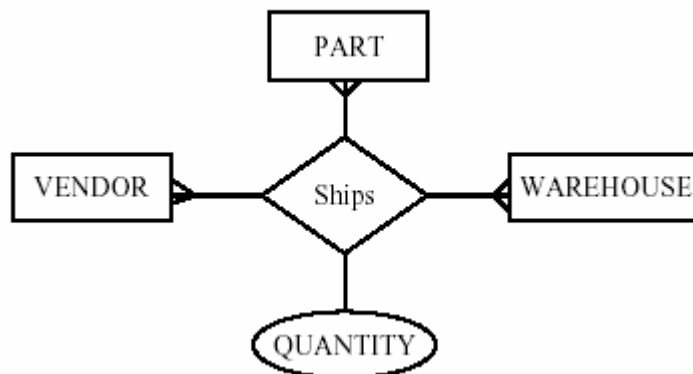

○ **N-ary Relationship**

Most relationships in data model are binary or at most ternary but we could define a relationship set linking any number of entity sets i.e. **n-ary** relationship

Entity sets involved in a relationship set need not be distinct. E.g.

Roommate = $\{(Student1, Student2) \mid Student1 \in Student \text{ Entity Set}, Student2 \in Student \text{ Entity Set and Student 1 is the Roommate of Student2}\}$

Relationship Cardinalities

The cardinality of a relationship is the number of entities to which another entity can map under that relationship. Symbols for maximum and minimum cardinalities are:

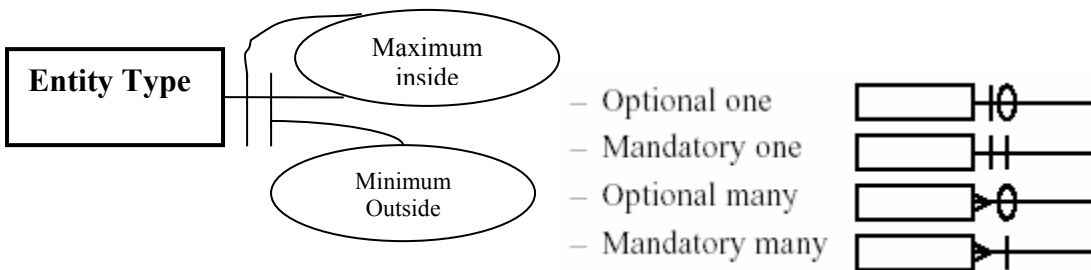

○ **One-to-One mapping:**

A mapping R from X to Y is one-to-one if each entity in X is associated with at most one entity in Y and vice versa.

○ **Many-to-One mapping:**

A mapping R from X to Y is many-to-one if each entity in X is associated with at most one entity in Y but each entity in Y is associated with many entities in X.

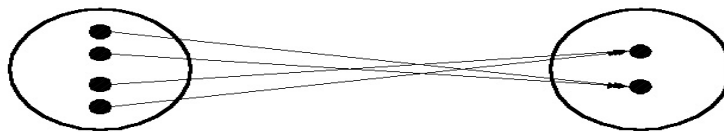
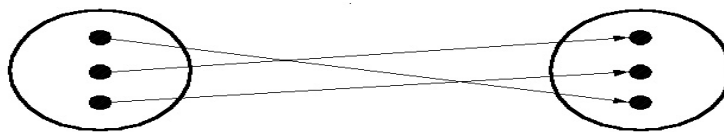

- **One-to-Many mapping:**

A mapping R from X to Y is one-to-many if each entity in X is associated with many entities in Y but each entity in Y is associated with one entity in X .

- **Many-to-Many mapping:**

A mapping R from X to Y is many-to-many if each entity from X is associated with many entities in Y and one entity in Y is associated with many entities in X .

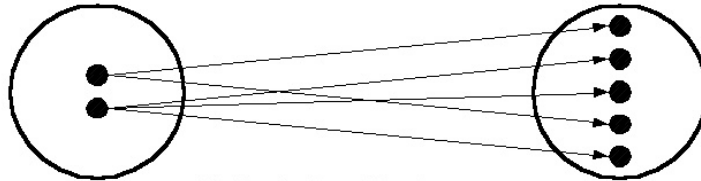

(c) One-to-Many Mapping

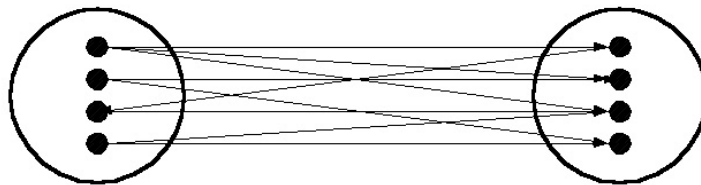

(d) Many-to-Many Mapping

Lecture No. 10

Reading Material

“Database Systems Principles, Design and Implementation” written by Catherine Ricardo, Maxwell Macmillan.	Page: 155 – 160
Hoffer	Page: 103 – 111

Overview of Lecture

- Cardinality Types
- Roles in ER Data Model
- Expression of Relationship in ER Data Model
- Dependency
- Existence Dependency
- Referential Dependency
- Enhancements in the ER-Data Model
- Subtype and Supertype entities

Recalling from the previous lecture we can say that that cardinality is just an expression which tells us about the number of instances of one entity which can be present in the second relation. Maximum cardinality tells us that how many instance of an entity can be placed in the second relation at most. Now we move onto discuss that what the minimum cardinality is.

Minimum Cardinality:

As the name suggests that the minimum cardinality is the inverse of the maximum cardinality so we can say that the minimum cardinality show us that how many instance of one entity can be placed in another relation at least. In simple words it can be said that the minimum cardinality tells that whether the link between two relations is optional or compulsory. It is very important to determine the minimum cardinality when designing a database because it defines the way a database system will be implemented.

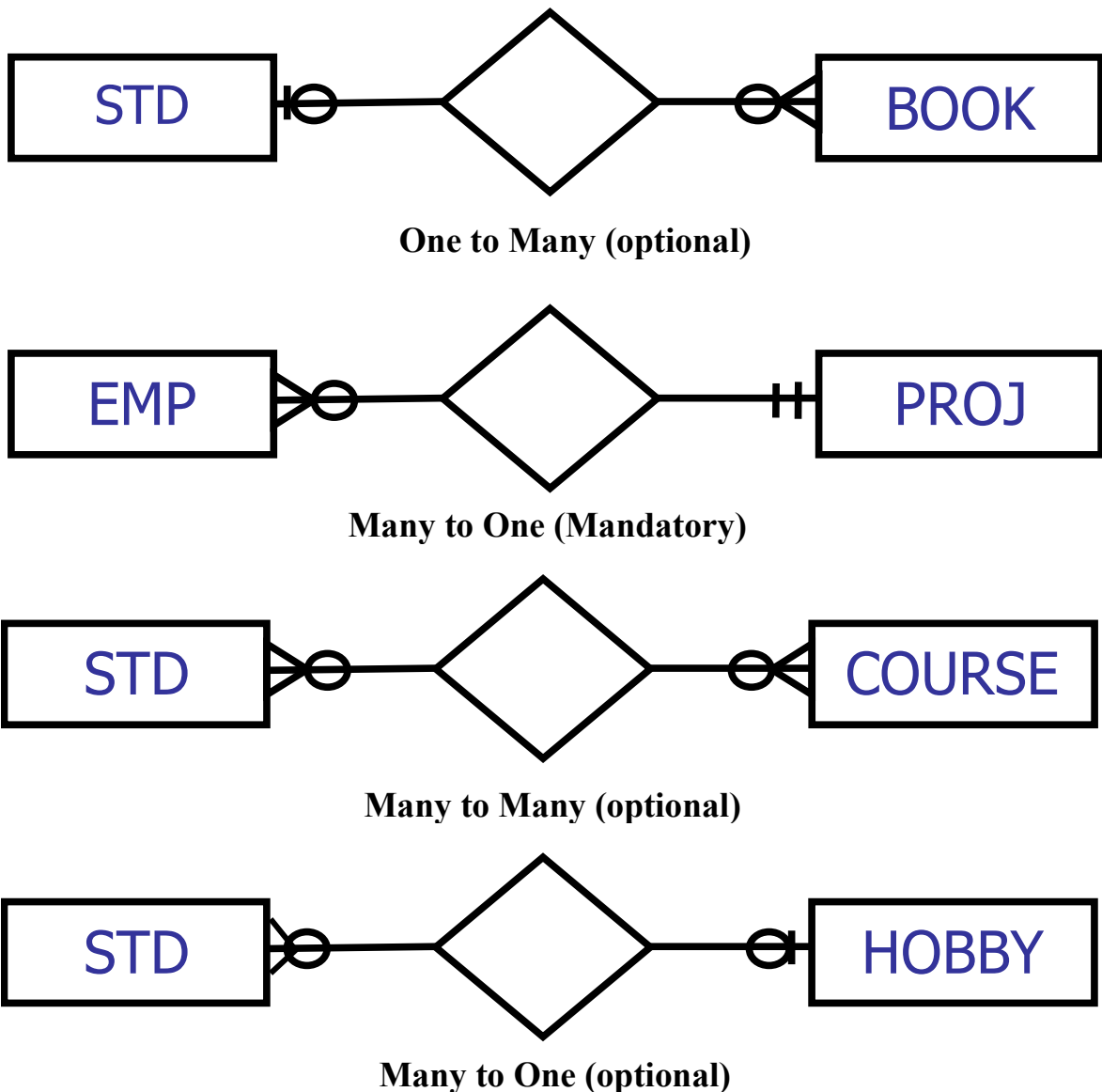



Fig 1: Different Cardinalities

In the figure-1 we have one to many cardinality between the entities. Maximum cardinalities are shown with the modifier that appears on the link and is adjacent to the entity rectangle. The other modifier which is next to the maximum cardinality modifier tells the minimum cardinality. The minimum cardinality modifier lies at more distance from the entity as compared to the maximum cardinality modifier.

Determination of the cardinalities is done by interviewing the users of the system and by the analysis of the organization.

The cardinality shown in First Part of the Figure-1 is shown using a relationship between a student and book; this can be a library scenario where students are borrowing books from the library. We can see in the diagram the shape  adjacent to the student entity it shows that the minimum cardinality for the student relationship is zero and maximum cardinality is one. Whereas on the other side of the diagram the shape  adjacent to

the book entity show that at most there can be many instances of the book associated with a single instance of student entity, and that there can be at-least no instance associated with the student entity. In general library scenario we can say that one student can borrow at least no and at most many books. Hence the minimum and maximum cardinality is shown.

In the second part of the Figure-1 we see a relationship between the Employee and project entities, the relationship describes one to many association between the project and the employees, It shows that there can be one project having a number of employees, but for the existence of one employee at one project is necessary. So the minimum and maximum cardinality on the project side of the relationship is one, and employees associated with each project can be many at most and none at-least.

Third part of the Figure-1 shows the association between the student and the course entities. Here we can see that the relationship between the student and the course is zero at least and many at most on both the sides of the relationship. The minimum cardinality with zero minimum is also called the optional cardinality. It also shows that one student can have registered more that one subjects and one subject can also be taken by many students. Also it is not necessary for a student to get registered one subject.

In the fourth part of the Figure-1 we can see the one to many cardinality between the student and hobby entities the cardinality descriptors show that a student may have no or at most one hobby, but it is worthwhile to notice that the cardinality of the hobby with the student in many but optional, now we can say that one hobby can be associated to nay student but there is a chance that no hobby is associated to one student at a certain time.

Other Notations:

The notation mentioned above is known as crow's foot notation for the expression of ER-Diagrams, there can be other notation as well which can be used for creating ER-Diagrams; one of these notations is shown in the Figure-2. We can see that the one to many cardinality shown in the first part of the diagram is expresses with single and double arrows. The Single arrow in this case shows the one and double arrow show the many cardinality.

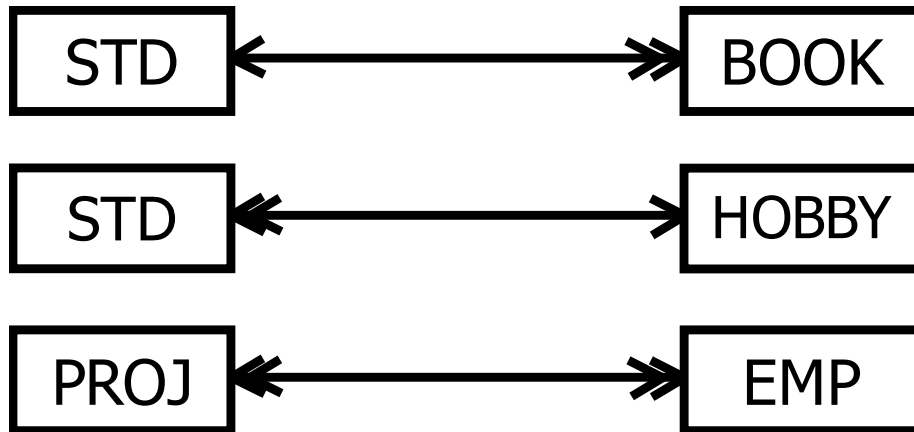

Fig. 2: Arrow-head notation

So the First part of the figure-2 show One to many cardinality, second part of the Figure shows many to one and the third part of the cardinality shows many to many cardinality between the entities involved.

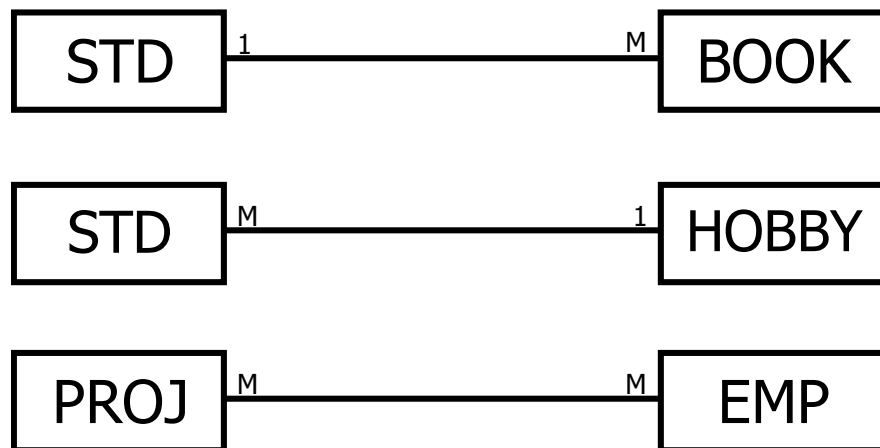

Fig. 3: Alphabetical notation

The above Figure shows another notation for creating ER-Diagrams which show that to show the one cardinality we have used 1 and for many cardinality M or N is used.

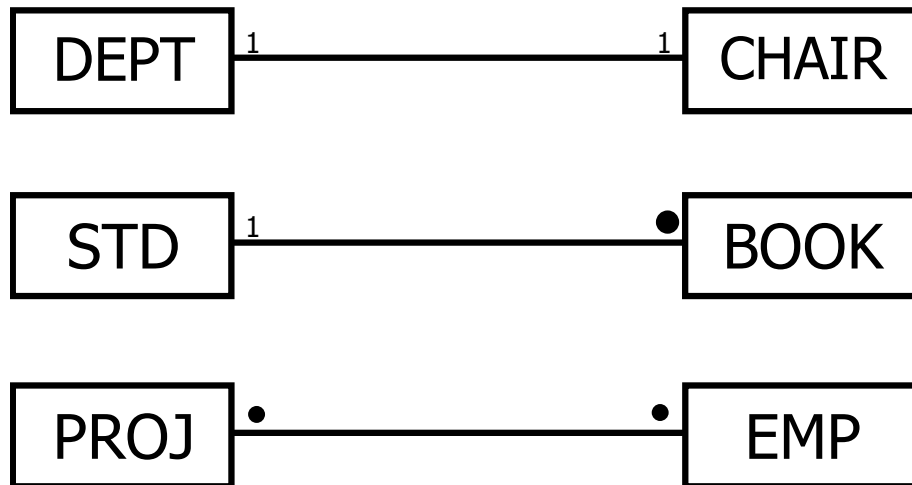

Fig. 4: Dot-based notation

Notations shown in the Figure-4 above as also used for creating ER-Diagrams where 1 is used for showing the single cardinality and the black filled Dot is used for showing many cardinality.

Roles in Relationships

The way an entity is involved in a relationship is called the role of the entity in the relationship. These details provide more semantics of the database. The role is generally clear from the relationship, but in some cases it is necessary to mention the role explicitly.

Two situations to mention the role explicitly

Recursive Relationship:

This is the situation when any attribute of one entity is associated with another attribute of the same entity. Such a link initiates from one entity and terminates on the same entity.

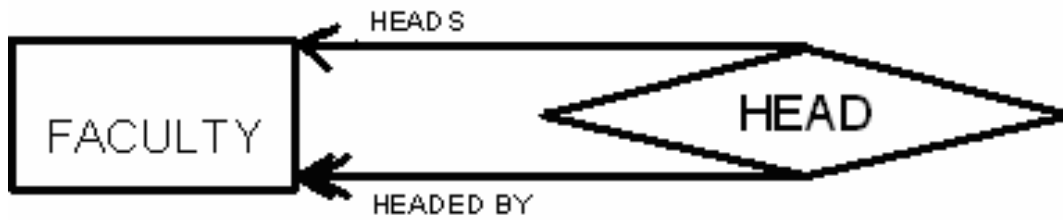

Fig-5: Roles in a unary relationship

Figure-5 above shows the recursive relationship which tells that in the faculty of a certain institute we can have one faculty member from among the same faculty as the head of the faculty. Now the role mentioned on the relationship tell that many Faculty instance are headed by one of the entity instance from the same faculty relation.

Multiple Relationships:

This is the second situation which needs the role to be mentioned on the relationship link when there is more than one relationship.

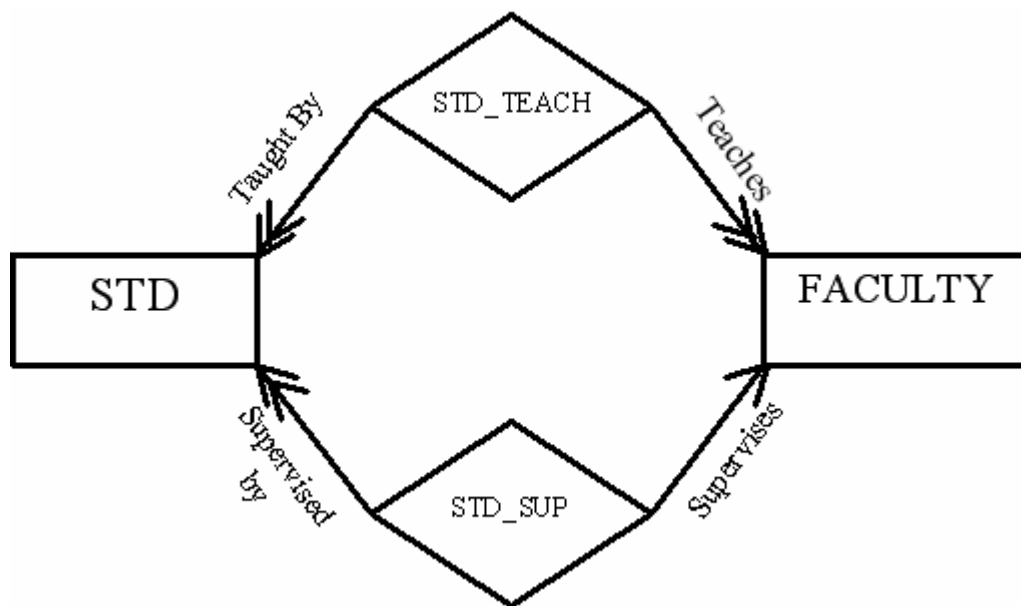

Fig. 6: Multiple relationships

As an example we can have a relationship of Faculty members and students as one faculty member may teach a number of students and at the same time one student may have been taught by a number of faculty members. This is one side of the picture. Now on the other side we can say that a faculty member may be supervising a number of students for their final projects. It shows two types of associations between the faculty and the students. So in this type of situation it is necessary to mention the role of the entities involved in the relationship.

Dependencies

Dependency is a type of constraint, for example once we define the cardinality or relationship among two entities it also is a constraint or check that tells that cardinality should be followed while populating data in relations. Similarly the dependency is a constraint. There are a number of dependency types which are expressed below:

The Existence dependency:

This is the type of dependency which exists when one entity instance needs instance of another entity for its existence. As we have seen earlier in case of employee of and organization and the projects associated with the employees there we see that employees are dependent on projects, it means that if no project is assigned to an employee it can not exist. In other words we can say that at a certain time an employee must be working on at least one project.

Identifier Dependency:

It means that the dependent entity incase of existence dependency does not have its own identifier and any external identifier is used to pick data for that entity. And to define a key in this entity the key of the parent entity is to be used in the key for this entity may be used as composite keys.

Referential Dependency:

This is the situation when the dependent entity has it own key for unique identification but the key used to show the reference with the parent entity is shown with the help of an attribute of the parent entity. Means to show the link of the parent entity with this entity there will be an attribute and a record in this entity will not exist without having a record in the parent entity. Despite of having its own identifier attribute.

This type of identifier or attribute in the weak entity is known as foreign key.

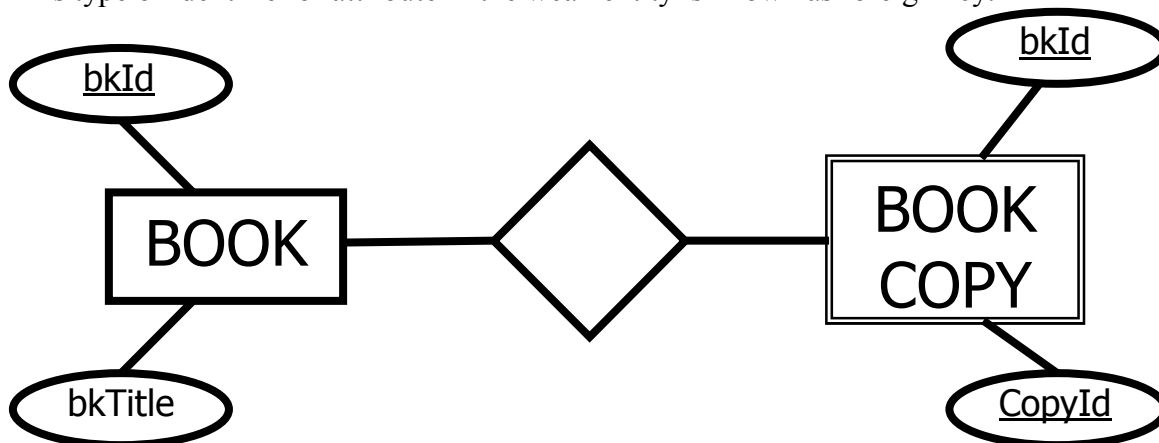

Fig-7

In the Figure-7 above the relation shown is expression the existence dependency where it is necessary for a book instance to exist if there exist the copies of the book with the same bkId.

Enhancements in E-R Data Model:

The topics that we have discussed so far constitute the basics of ER-Model. The model is further extended and strengthened with addition of some new concepts and modeling constructs, which are discussed below

Super-type and Subtypes

These are also relationships existing between entities, also referred to as generalized and specialized respectively let us examine the figure below to grasp the idea of super-type and subtype.

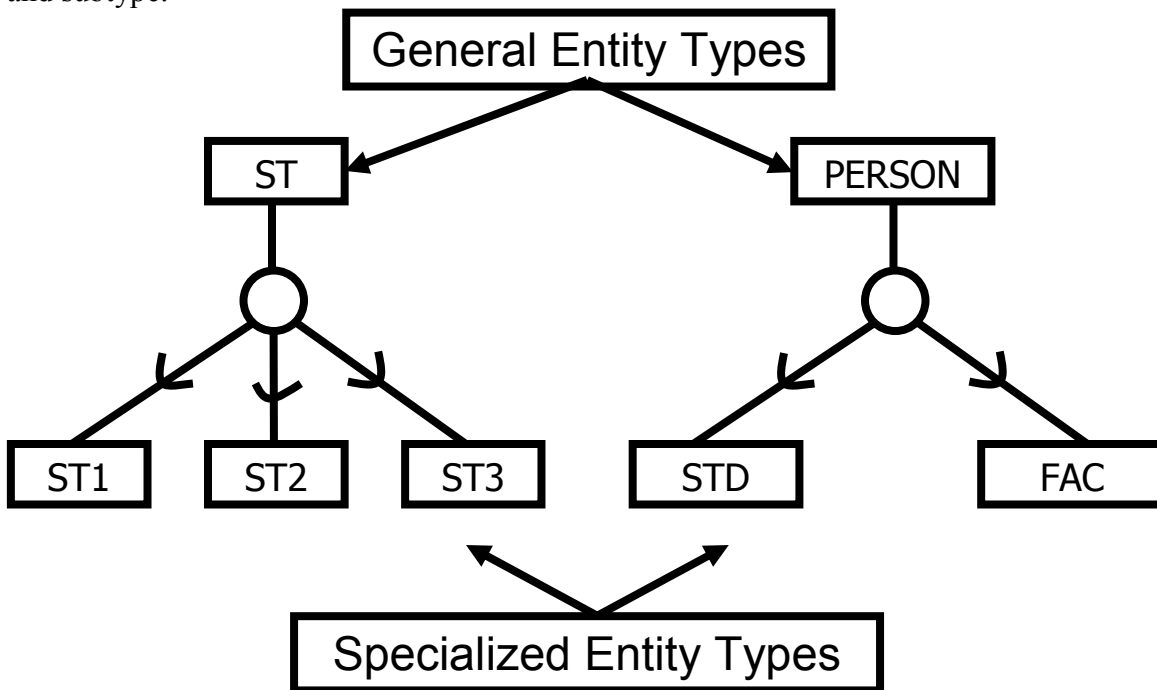

Fig-8 (Super-types and Subtypes)

In the Figure:8 show above there are different levels of existence of entities, at the top level we have general entity type, which are described as having a number of Subtype entities, these sub entities are in-turn acting as supertypes entities for a number of other entities. As we see in case of person supertype we can have further classify the person entity as Student (STD) and Teacher of Faculty member (FAC). Subtype entities are expressed with a link to the supertypes having an arc on the link—the arms of which

point to the supertype entity. As we move downward the distributed entities are known as specialized entities.

In the next Lecture the process of Generalization and Specialization will be discussed in detail.

Summary:

In this lecture we have discussed an important topic of cardinalities and their representation in the E-R data model. For a correct design the correct identification of cardinalities is important.

Lecture No. 11

Reading Material

“Database Systems Principles, Design and Implementation” written by Catherine Ricardo, Maxwell Macmillan.	
--------------------------------------------------------------------------------------------------------------	--

Overview of Lecture

- Inheritance
- Super type
- Subtypes
- Constraints
- Completeness
- Disjointness
- Subtype Discrimination

According to the Microsoft Dictionary of Computing

Inheritance Is

The transfer of the characteristics of a class in object-oriented programming to other classes derived from it. For example, if “vegetable” is a class, the classes “legume” and “root” can be derived from it, and each will inherit the properties of the “vegetable” class: name, growing season, and so on². Transfer of certain properties such as open files, from a parent program or process to another program or process that the parent causes to run.

Inheritance in the paradigm of database systems we mean the transfer of properties of one entity to some derived entities, which have been derived from the same entities.

Super types and Subtypes

Subtypes hold all the properties of their corresponding super-types. Means all those subtypes which are connected to a specific supertype will have all the properties of their supertype.

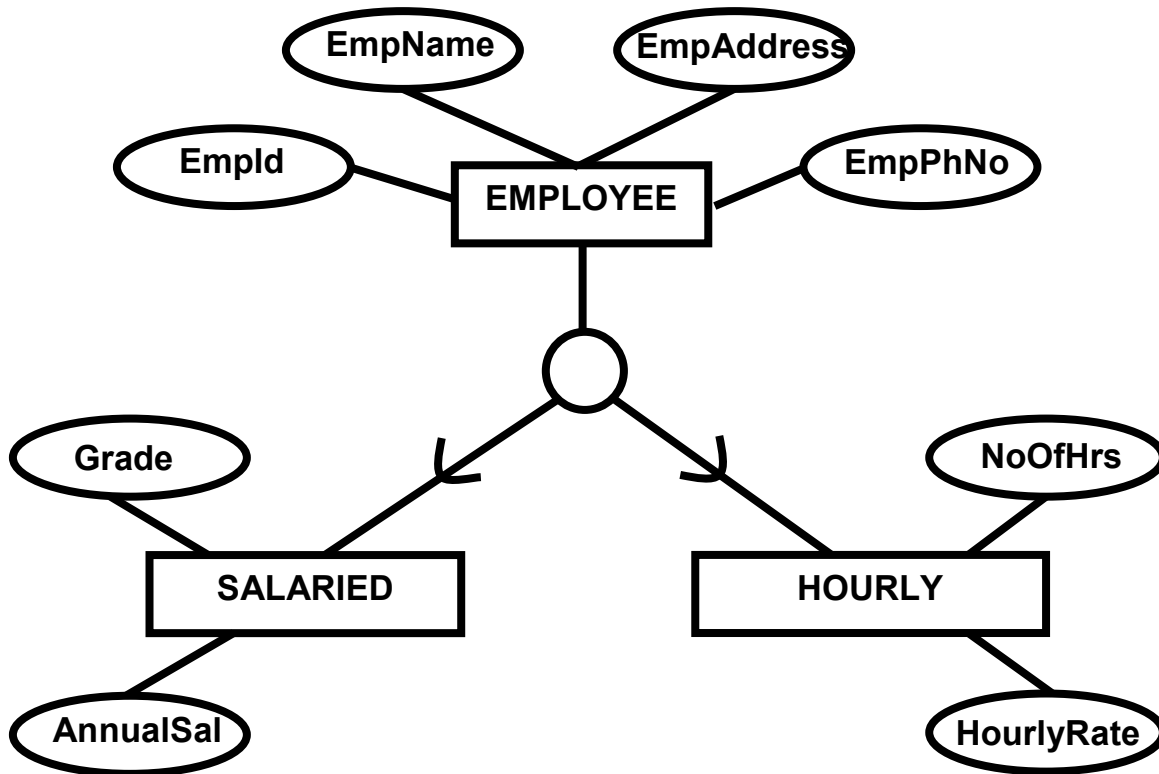

Fig-1 a

The Figure:1 above shows that the supertype and subtype relation between the SALARIED and HOURLY employees with the supertype entity EMPLOYEE, we can see that the attributes which are specific to the subtype entities are not shown with the supertype entity. Only those attributes are shown on the supertype entity which are to be inherited to the subtypes and are common to all the subtype entities associated with this supertype.

The example shows that there is a major entity or entity supertype name EMPLOYEE and has a number of attributes. Now that in a certain organization there can be a number of employees being paid on different payment criteria.

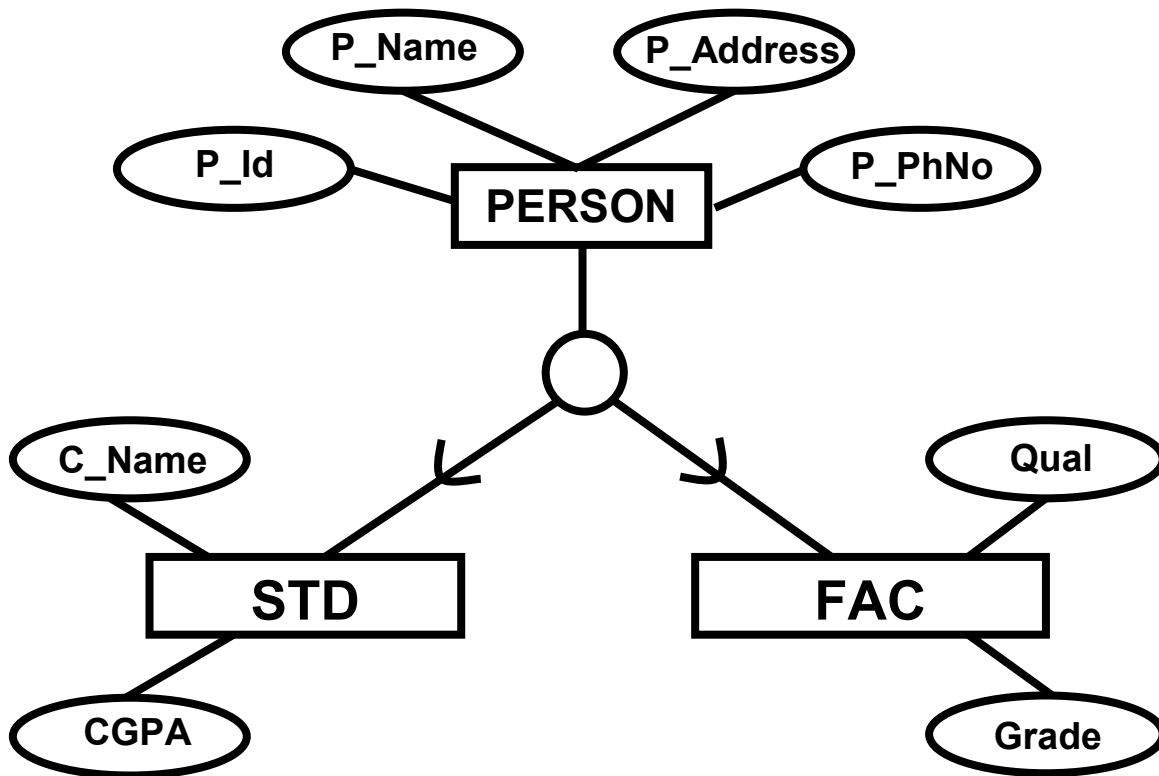

Fig – 1 b

The second example is that of student and the Faculty members who are at the super level same type of entities. Both the entities at the super level belong to the same entity of type Person. The distinct attributes of the student and faculty members are added later to the sub entities student and fac.

Supertype / subtype Relationship:

The use of supertype and subtype for the entities is very useful because it allows us to create hierarchy of the entities according to the attributes they have and we need not to write all the attributes again and again. We can group similar types of entities and the attributes associated with those entities at certain levels.

This also adds clarity to the definitions of the entities as it is not necessary to write the attribute again and again for all the entities.

Moreover it also eases the operation of removing or adding attributes from the entities, here it is worth noting that adding an attribute at the super entity level will add the

attribute to the below listed or derived sub entities and removing the attribute will remove the attribute from the entities at sublevels in the same way.

The process of identifying supertype and creating different type of sub entities is supported by the general knowledge of the designer about the organization and also based of the attributes of the entities which are entities existing in the system..

Specifying Constraints

Once there has been established a super/sub entity relationship there are a number of constraints which can be specified for this relationship for specifying further restrictions on the relationship.

Completeness Constraint

There are two types of completeness constraints, partial completeness constraints and total completeness constraints.

Total Completeness:

Total Completeness constraint exist only if we have a super type and some subtypes associated with that supertype, and the following situation exists between the super type and subtype.

All the instances of the supertype entity must be present in at one of the subtype entities, i.e.—there should be not instance of the supertype entity which does not belong to any of the subtype entity.

This is a specific situation when the supertype entities are very carefully analyzed for their associated subtype entities and no sub type entity is ignored when deriving sub entities from the supertype entity.

Partial Completeness Constraint:

This type of completeness constraint exists when it is not necessary for any supertype entity to have its entire instance set to be associated with any of the subtype entity.

This type of situation exists when we do not identify all subtype entities associated with a supertype entity, or ignore any subtype entity due to less importance or least usage in a specific scenario.

Disjointness Constraint

This rule or constraint defines the existence of a supertype entity in a subtype entity. There exist two types of disjoint rules.

- Disjointness rule
- Overlap rule

Disjoint constraint:

This constraint restricts the existence of one instance of any supertype entity to exactly one instance of any of the subtype entities.

Considering the example given in Fig 1a it is seen that there can be two types of employees, one which are fixed salary employees and the others are hourly paid employees. Now the disjoint rule tells that at a certain type an employee will be either hourly paid employee or salaried employee, he can not be placed in both the categories in parallel.

Overlap Rule:

This rule is in contrast with the disjoint rule, and tells that for one instance of any supertype entity there can be multiple instances existences of the of the instance for more than one subtype entities. Again taking the same example of the employee in an organization we can say that one employee who is working in an organization can be allowed to work for the company at hourly rates also once he has completed his duty as a salaried employee. In such a situation the employee instance record for this employee will be stored in both the sub entity types.

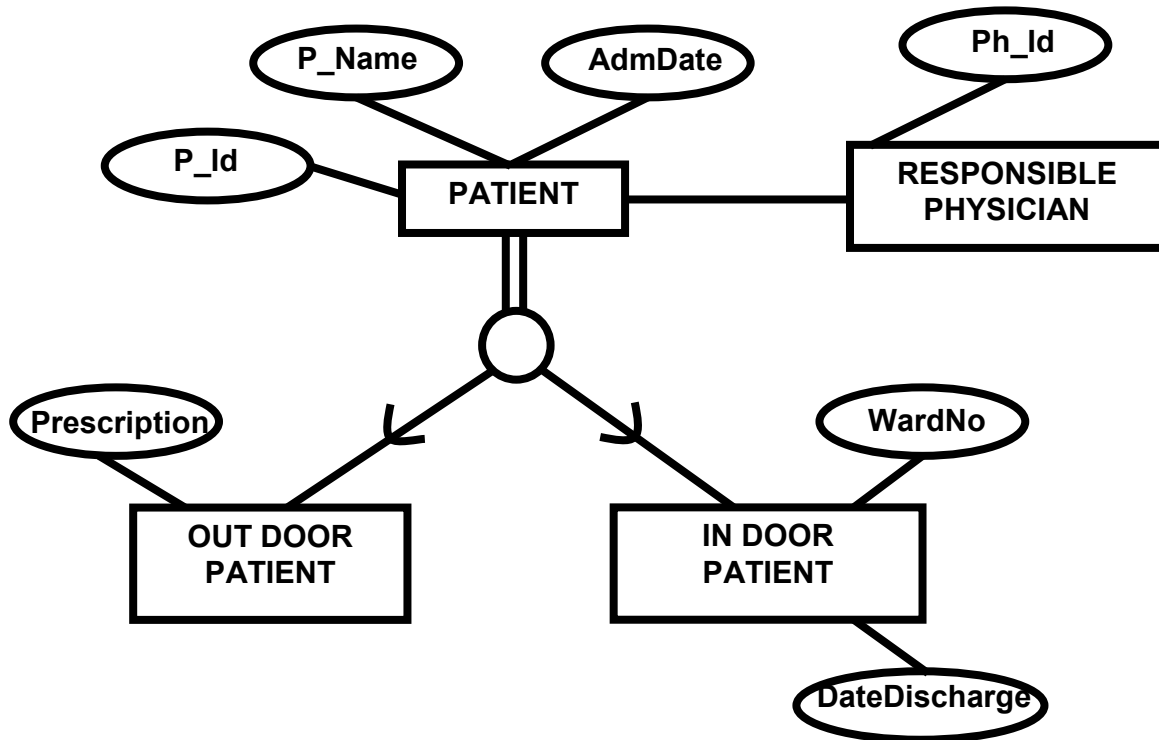

Fig 2-a

In the example the completeness of the relation is shown between the supertype entity and the subtype entity, it shows that for the data of patients we can have only two type of patients and one patient can be either an outdoor patient or indoor patient. In it we can see that we have identified all possible subtypes of the supertype patient. This implies a completeness constraint. One more thing to note here is the linked entity physician to the patient entity. And all the relationships associated with the supertype entity are inherited to subtype entities of the concerned supertype.

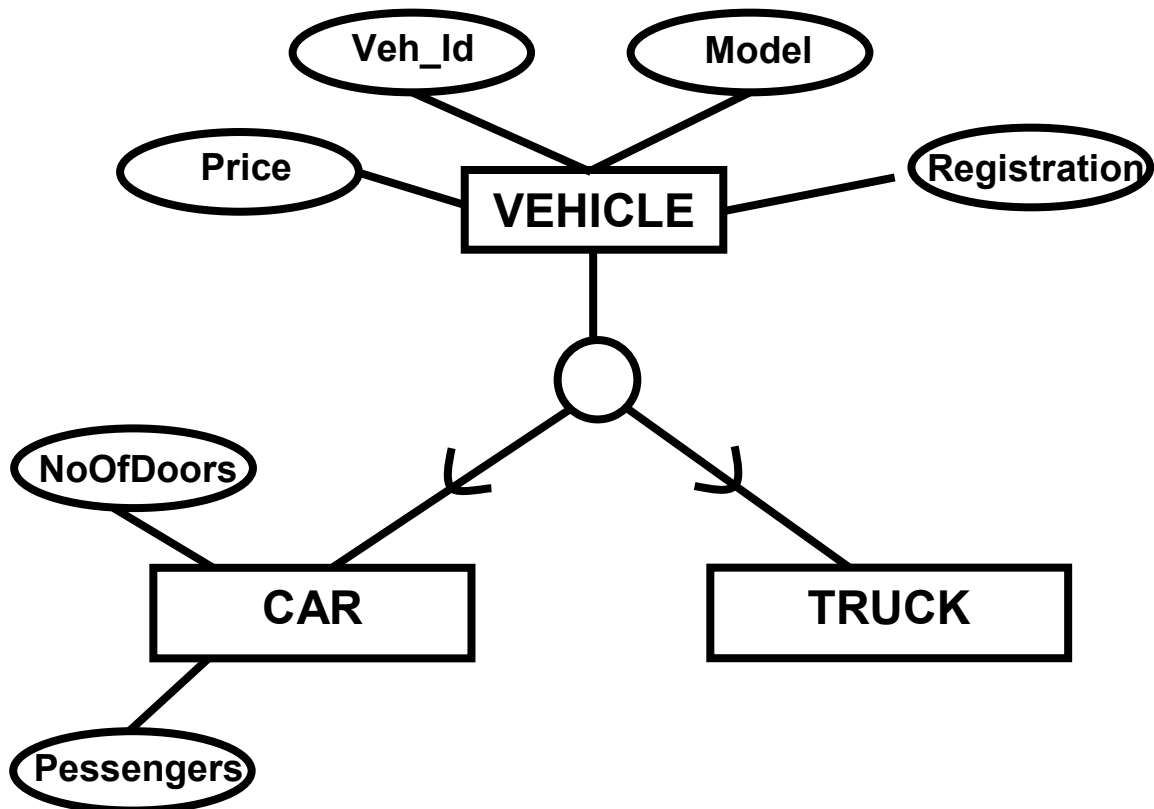

Fig 2-b

The Figure2b shows the supertype and subtype relationship among different type of vehicles. Here we can see that the Vehicle has only two subtypes, known as Truck and Car, As it is normal to have a number of other vehicles in the company of a certain type but when we have noted just a limited number of vehicles then it means that we are not interested in storing information for all the vehicles as separate entities. They may be stored in the vehicle entity type itself and distinct vehicle may be stored in the subtypes car and truck of the Vehicle.

This is a scenario where we have the freedom to store several entities and neglect others, and it is called as partial completeness constraint rule.

After the discussion of the Total Completeness and Partial completeness let us move to the next constraint that is disjointness and check for its examples.

Again in the Figure 2-a. we have the environment where patient entity type has two subtypes indoor and outdoor patient. To represent disjointness we place the letter “D” in the circle which is splitting the super entity type into two sub entity types. Suppose that the hospital has placed a restriction on the patient to be either a n indoor patient or

outdoor patient, in such a case there exists disjointness which specifies that the patients data can not be place in the database in both the subtype entities. It will be wither indoor or outdoor.

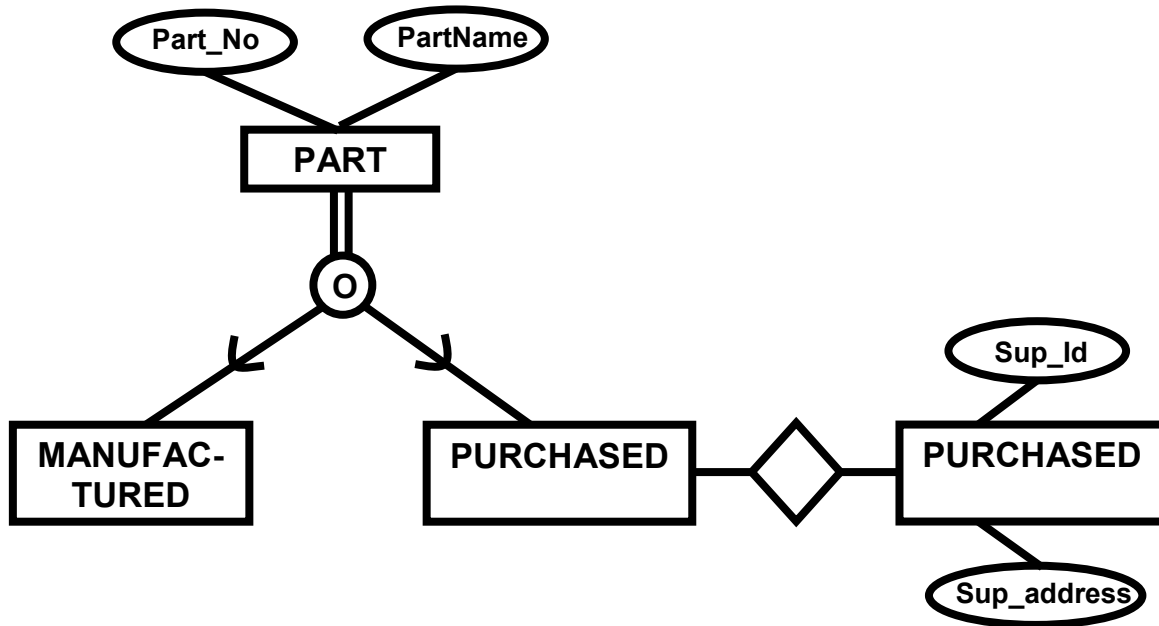

Fig- 3

The figure 3 above shows the second type of disjoint constraint which tells that the entity subtype instance can be repeated for any single entity supertype instance. We can see the relationship of a certain hardware company for the parts provided by the company to its clients. Now there may exist an overlapping situation for a certain part which is to be provided to a certain firm, but the manufactured quantity of that part is not enough to meet the specific order, In this situation the company purchases the remaining the deficient number of parts form the other suppliers. We can easily say that the data for that specific part is to be placed in both the entity subtypes. Because it belongs to both the subtype entities, this is an overlapping situation and expresses disjointness with overlapping. Another important thing which is to be noted here that the purchased part subtype entity has a relationship with another entity where the data for the suppliers is stored from whom the parts are bought. Now this relation does not have nay interaction with the manufactured parts relation as it is not connected with its supertype i.e.—parts supertype entity.

Considering the above discussed we can have four different types of combination existing for the supertype and subtype entities.

- Complete Disjoint
- Complete Overlapping
- Partial Disjoint
- Partial overlapping

Subtype Discriminator

This is a tool or a technique which provides us a methodology to determine that to which subtype one instance of a supertype belongs.

To determine the relation we place an attribute in the entity supertype which can specify through its value, that to which entity subtype it belongs.

For example we consider the example

There can be two different situations which specify the placement or relationship of a supertype entity instance in a subtype entity instance. First situation is that of disjoint situation where one supertype entity instance can be placed only in one subtype of that supertype. Let us consider the example of vehicles above in Figure-2-b it show that there can be two different vehicles car and truck associated with the supertype vehicle now if we place an attribute named Vehicle_type in the supertype we can easily determine the type of the associated subtype by placing a C for car and a T for truck instance of the vehicle.

The other situation where the Subtype discriminator is required the overlapping constraint; it is the situation where one supertype attribute can be placed in more than one subtype entities.

Considering again the part example shown in Figure 3, which has an overlapping constraint; In this situation we can have many solution one common solution is to place two attribute in the supertype one for manufactured and other one for purchased. We can combine them as a composite attribute, when we place Y for manufacture and N for

Purchased then it means the part is manufactured by the company, and similarly the following situation will give us further information

Attribute		
Manufacture	Purchased	Result
Y	Y	Manufacture Purchased
Y	N	Manufactured
N	Y	Purchased.

Significance of Subtype Discriminator:

Existence of subtype discriminator helps us a lot in finding the corresponding subtype entities, although we can find a subtype entity instance without having a subtype discriminator in the supertype but that involves lots of efforts and might consume a huge time in worst case situations.

This concludes out discussion of The ER Model in the course.

Lecture No. 12

Reading Material

“Database Systems Principles, Design and Implementation” written by Catherine Ricardo, Maxwell Macmillan.	
--------------------------------------------------------------------------------------------------------------	--

Overview of Lecture

In today's lecture we will discuss the ER Data model for an existing system and will go through a practice session for the logical design of the system

The system discussed is an examination section of an educational institute with the implementation of semester system.

Steps in the Study of system

Preliminary study of the system

- Students are enrolled in programs.
- The programs are based on courses
- Different courses are offered at the start of the semester
- Students enroll themselves for these courses at the start of semesters
- Enrolled courses by students and offered courses must not be same.
- The difference is due to the individual situation of every student, because if one student has not pass a certain course 'A' in the previous semester he will not be able to register for a course 'B' offered in this semester as the course 'A' is the prerequisite for course 'B'.
- After valid registration classes start.
- A Course which is offered is assigned to a teacher also
- There can be any mid term exams and in this system we have only one mid term
- All the students are given assignments and quizzes and are awarded marks against their performance.
- Result of the student is prepared on the basis of assignment marks, sessional and mid term marks and the final exam.
- GP (Grade point) for students is calculated in each subject.
- Average grade point is calculated on the basis of GPs in individual subjects

- And the Cumulative GPA is calculated for all the passed semesters.

Outputs Required

- Teachers and controller need class list or attendance sheet, class result; subject and overall
- Students need transcripts, semester result card, subject result

Entities associated with the system

- Students
- Teachers
- Controllers

Once the analysis of the system is done it is important to make a draft of the system using a standard tool which specifies the component and design of the system. This design is useful because anyone using the design can work on the existing system and clearly understand the working without working on the system from the scratch.

Tool used for such graphical design is Data Flow Diagram (DFD)

In the Figure -1 of the system we have a context diagram of the system which shows integration of different entities with the examination system, these include Registration system, controller, student and teacher entities.

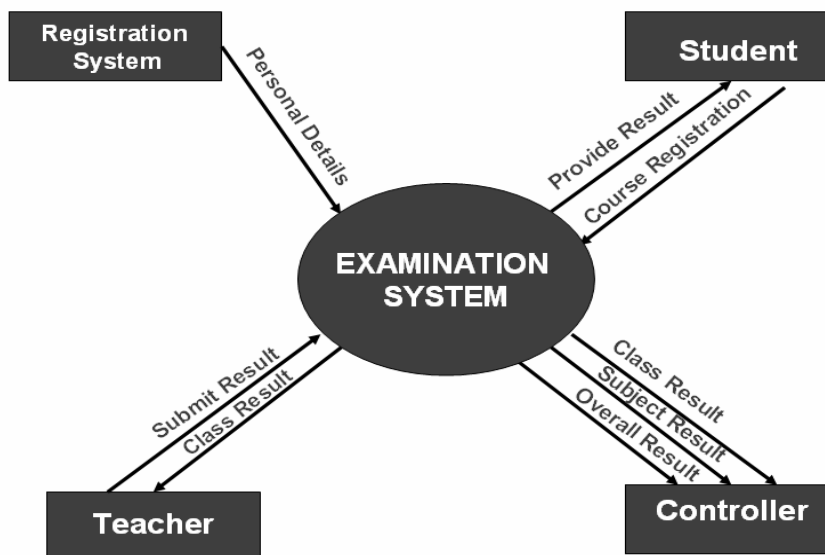

Fig-1

- From the diagram we can understand basic functionality of the system and can find how the data is flowing in the system and how different external entities are communicating or interacting with the system.

- First of all we have registration system, which provides the data of students to the systems once the registration process has been completed, this data is now free of errors in terms of validity of a certain student for a certain course or a semester.
- Second external entity interacting with the system is the teacher, a Teacher is given a list of students who are enrolled in a class and the registration system has declared them as valid students for that very course. Then the teacher allows those students in the class and continues the process of teaching the class, during this process the teacher takes test of the students and prepares papers for the students and also prepares quizzes to be submitted by students. All the data of students' attendance quizzes and assignments along-with different sessional results is then submitted by the teacher to the examination system which is responsible for preparation of results of the students
- Third interacting entity with the system is the controller's office it is provided with the semester overall result, subject results and also the result of each class for performance evaluation and many other aspects.
- Fourth entity is student which externally interacts with the system for getting its result, the result is submitted to the student and may be in one of different forms such as, transcript and result card etc.

Level 0 Diagram

The three major modules which have been identified are given below our level 0 diagram will be based on these three modules and will elaborate and describe each of the modules in details.

- Subject registration
- Result submission
- Result calculation

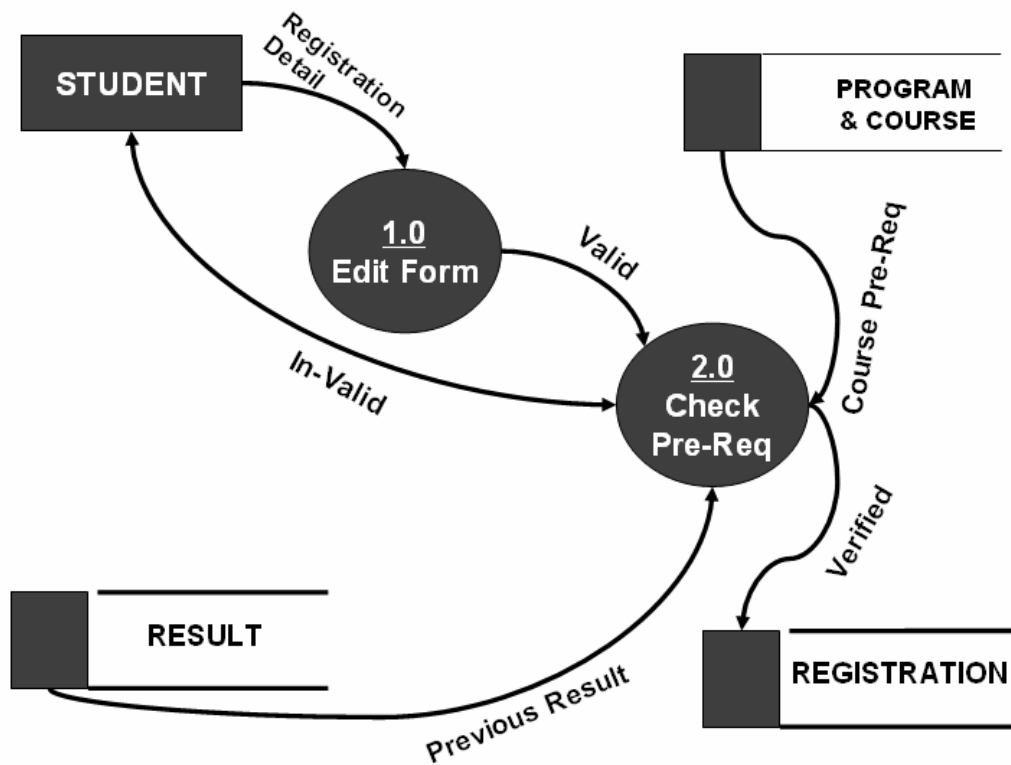

Fig 2

The first module identified in the system is the Registration of the students for the system. As the DFD shows, a student applies for registration along with certain registration information which is required by the system. Process 1.0 of the system checks the validity of information in the form. If the registration form is found to be valid, the information in the form is passed onto the second process where the validity of registration is determined by checking certain prerequisites for the courses to which the student wishes to be enrolled. After the prerequisite checking, the data of the student is stored in a registration database for use by other processes in the system.

During this process, the result of the students is also checked for the previous semester or previously studied subject to confirm whether the student has passed a certain prerequisite subject before he can attempt to enroll for a second course which is based on that prerequisite.

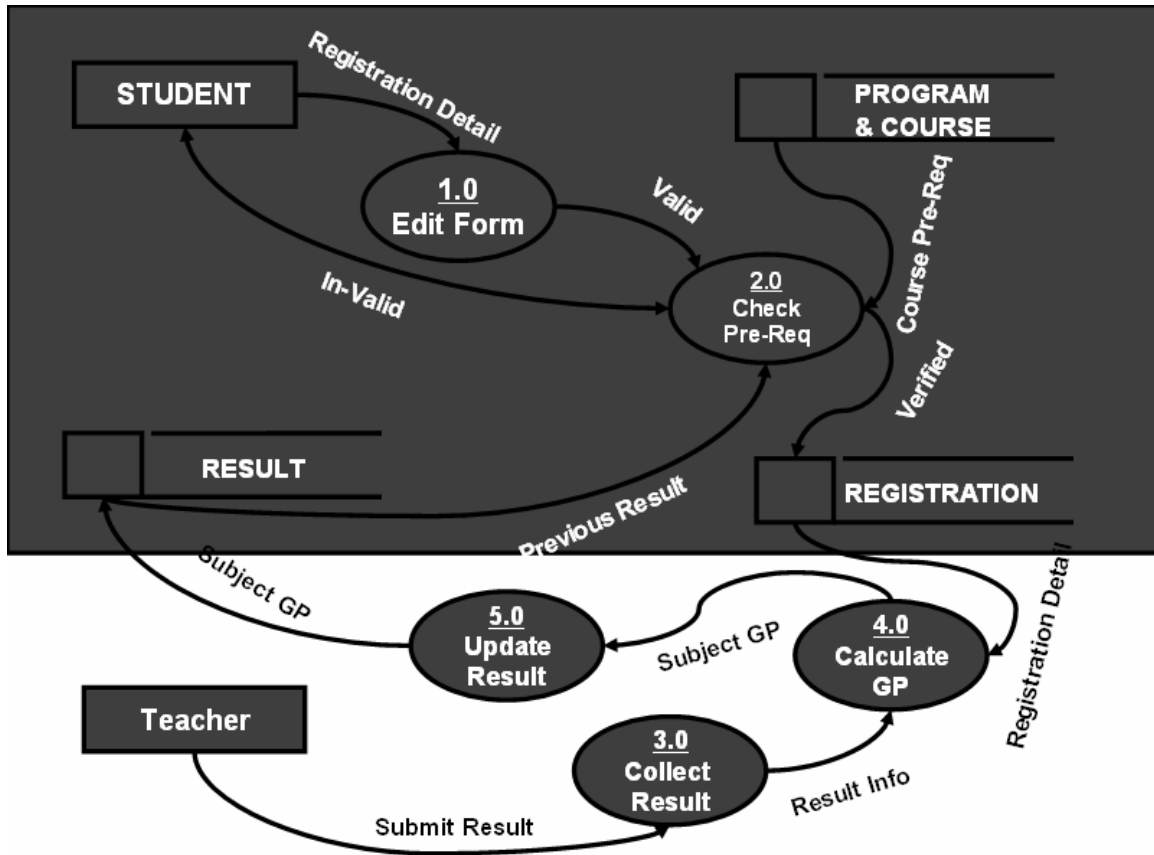

Fig-3

The Second DFD is in fact combination of the last diagram and some new details to the DFD this portion adds the result submission to the whole process of the system The teacher is the external entity here which is submitting the result, the result collection process is numbered 3.0, result is submitted by the teacher in parts, i.e. –separately for assignments, quizzes, tests, sessional and final result. The Collection process then forward the collected result to the Calculate GP Process, this process calculates the Grade point for the subject, the result with GP calculated is then moved forward to the update result process which then makes a change in the result data store by updating the result data for that specific student.

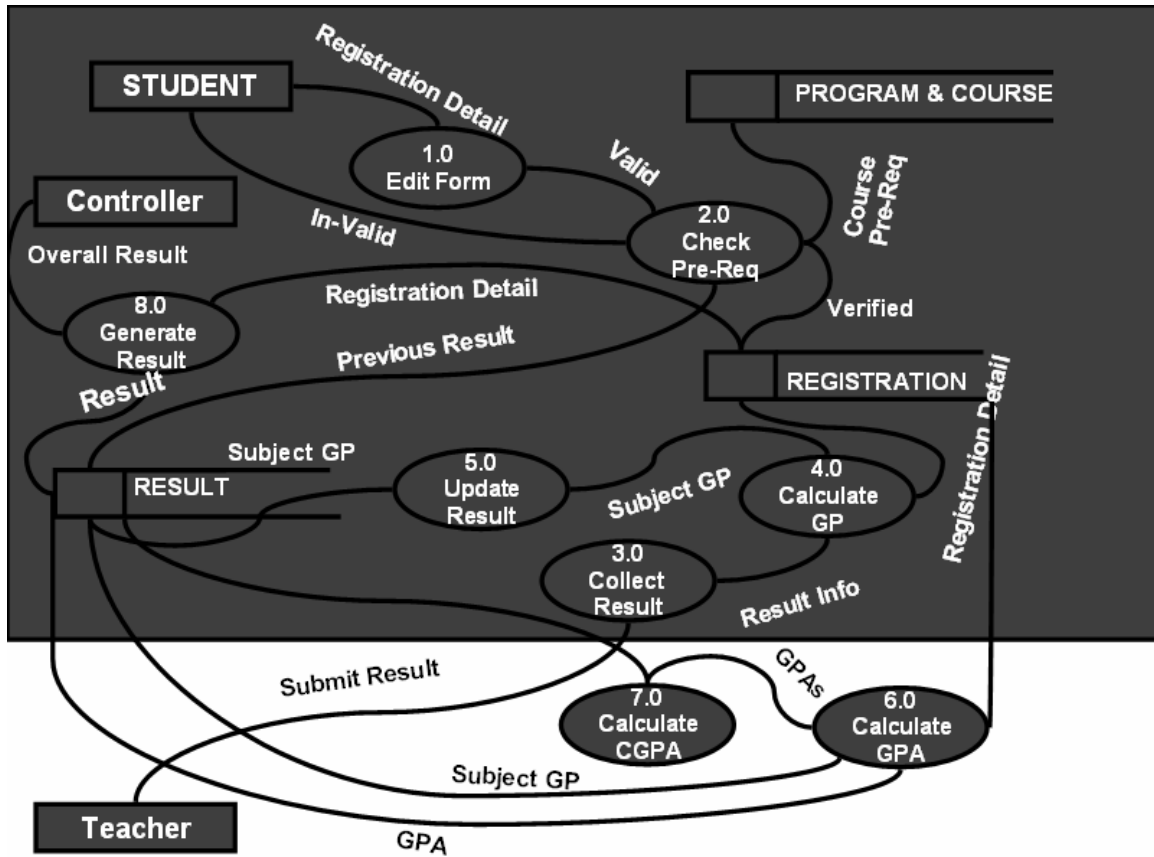

Fig-4

After the process of result submission the result for all the subjects is taken and the GPA is calculated, once the GPA is calculated the it is used for further calculation of CGPA and is forwarded to another process which is numbered 7.0 this process will calculate the CGPA by taking all the results of the current and previous semesters.

Further detailed diagram i.e.—Detailed DFD can be created using the given level 0 DFD and by expanding all the Processes further.

Cross Reference Matrix: doth:

This matrix is used to find out that what values or attributes will appear in which reports, for this purpose we write the major item names on a matrix in the row wise order and the reports which will be generated will be written on top or in column wise order.

Cross Reference Matrix

	Transcript	Semester Result Card	Attendance Sheet	Class Result (Subject Wise)	Class Result
Course_Name	✓	✓		✓	
CGPA	✓	✓			✓
Date	✓	✓		✓	✓
F_Name	✓	✓			
NameOfStudent		✓			
NameOfProgram		✓			
Reg_No	✓	✓	✓	✓	✓

This process infact is just cross link So the first Item transcript which may be or it will be needed by a specific student, second is Result card, next is attendance sheet then we have Class result (Subject wise) and finally the Class result as a whole, here by subject wise class result means that all the results of a specific class for a specific student considering each component, such as assignments, quizzes, sessional and terminal results.

Similarly all the mentioned items are marked with a tick which may needed by a certain output.

Let us see how the DFD and CRM are used in creating the ER-Diagram

The process of Creating ER-Diagram in fact lies in the Analysis phase and is started with identifying different entities which are present in the system. For this purpose we can use the DFD first of all.

Lets check our DFD, from there we can find the following entities.

Student	Controller
Courses	Teachers
Courses Offered	Programs
Registration	Results
Semester	

Here the point to be noted is that, we have picked the controller as the entity, although the controller is acting as an external entity for providing or getting information from the system, but in case of ER-Diagram the controller can not be represented as an entity because there is only one controller in any examination system and for such an entity instances a complete entity is not used.

So in this way we can exclude the controller entity, we will also take care of other entities before including them in our ED-Diagram. Another such example is results, which may not be as it is, added to the ER-Diagram, because there can be a number of result types at different stages of the Process, so there will be a number of different results.

We use our CRM in creating the ER-Diagram, because when we see the CRM, it has a number of item/attributes appearing on it, now from there we can see that whether these items belong to the same entity or more than one entity. And even if they belong to multiple entities we can find the relationship existing between those entities.

Considering our CRM we have transcript, it has a number of items appearing on it, as we know that there is to appear result for each semester on the transcript. So the attributes which belong to the personal information of the student shall be placed in the student entity and the data which belongs to the students' academic data will be placed in the courses or results entity for that student.

In the next phase we have to draw different entity type and the relationship which exist between those entities.

These we will discuss in the next lecture that how we draw relationships between different entities.

Lecture No. 13

Reading Material

Case Study	
------------	--

Overview of Lecture

- E – R Diagram of Examination System
- Conceptual Data Base Design
- Relationships and Cardinalities between the entities
- In the previous lecture we discussed the Preliminary phase of the Examination system. We discussed the outputs required from the system and then we drew the data flow diagrams DFDs. From this lecture we will start the conceptual model of the system through E-R Diagram.

Identification of Entity Types of the Examination System

We had carried out a detailed preliminary study of the system, also drawn the data flow diagrams and then identified major entity types. Now we will identify the major attributes of the identities, then we will draw the relationships and cardinalities in between them and finally draw a complete E-R Diagram of the system.. So first of all we will see different attributes of the entities.

Program:

This entity means that what different courses are being offered by an institute, like MCS, BCS etc. Following are the major attributes of this entity:-

- **pr_Code.** It can be used as a primary key of the entity as it would always be unique for example MBA, MCS, etc.
- **max_Dur** It means that what is the maximum duration of any particular course , like 1 year , 2 years and so on.
- **no_of_Semesters** How many semesters this program has like four ,six and so on.
- **Pr_Lvl** This course is of undergraduate, graduate or post graduate level.

Student:

Following are the major attributes of this entity:-

- **Reg_No** This can be used as a primary key for this entity as it will be unique for every student.
- **st_Name** This would be the first name of all the students of an institute.
- **St_Father_name** This would represent the father's name of a student.
- **St_date_of_Birth.** The date of birth of all students including year , month and day.
- **st_Phone_no**
- **st_GPA** This is a very important attribute. Now to know the GPA of any student, we need to know the student reg no and the particular semester. So this is a multi valued attribute as to know the GPA, different attributes values are required. So this represented by a relation, which will be discussed in the relationships in between entities.
- **st_Subj_Detail** This is also a multi valued attribute ,as to know the marks in mid terms and final papers , student reg no and the particular subject are required

Teacher:

Following are the major attributes of this entity: -

- **teacher_Reg_No** This can be used as a primary key for this entity as it will be unique for every teacher.
- **teacher_Name** This would be the first name of all the teachers of an institute.
- **teacher_Father_name** This would represent the father's name of a teacher.
- **Qual.** The qualification of a teacher like Masters or Doctorate.
- **Experience** This can also be a multi-valued attribute or a single valued attribute. If only total experience of any teacher is required then it can be single valued, but if details are required as per the different appointments, then in that case it would be multi valued.
- **teacher_Sal** The total salary of the teacher.

There is one thing common in between teacher and student an entity that is the personal details of both, like name, father's name and addresses.

Course:

Following are the major attributes of this entity: -

- **course_Code** This can be used as a primary key for this entity as it will be unique for every course like CS-3207.
- **course_Name**
- **course_Prereq** This would also be a multi valued attribute as there can be a multiple requisites of any course . For example, Networking can have pre-requisites of Operating System and Data Structures. In this case this is a

recursive relation as pre-requisite of a course is a course. We will treat it as a recursive relation here.

- **Courses_Offered_in** This is also a multi valued attribute as to know the courses offered , program and semester both are required so this can also be represented by a relation

Semester:

Following are the major attributes of this entity: -

- **semester_Name** This can be used as a primary key for this entity as it will be unique for every semester like fall 2003 or spring 2004.
- **semester_Start_Date** The starting date of the semester
- **semester_End_Date** The ending date of the semester

Derived Attributes

There are certain attributes in the examination system which is derived like CGPA of a student can only be achieved from the semesters GPA. Similarly FPA of any particular semester can be achieved from subjects GPA of the semester. So this has to be kept in mind while drawing the E-R Diagram of the system.

Relationships and Cardinalities in between Entities

Relationships and cardinalities in between entities is very important. We will now see the relationship of different entities one by one. The block diagrams of different entities are as under: -

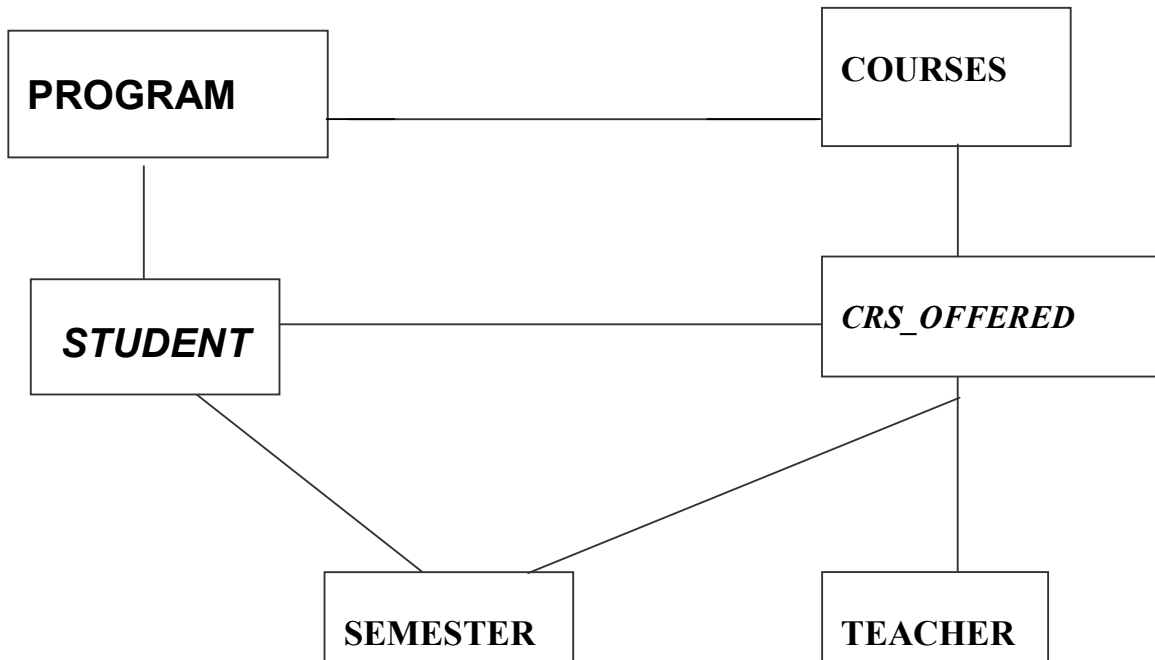

Program and Courses

The relationship between program and courses is that, if we want to know the courses in any particular program then the course codes and program codes are required. The cardinality between program and courses is of one to many (1 - *), which means that any program will have minimum one course, and as many as required for that particular program. The cardinality of courses and program can be zero to many (0 - *). It means that if an institution wants, it can have a course without even any program as well. This course can be included in any program later on.

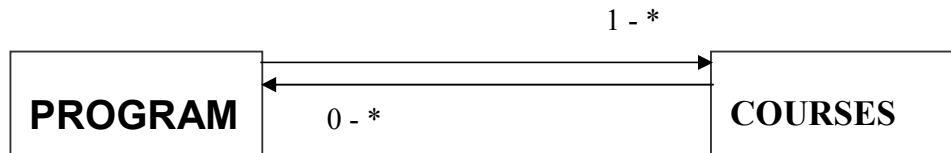

Students and Programs

The cardinality in between student and program is one, which means that every student can have minimum and maximum one program at any time. The cardinality in between programs and students can be zero to many (0 - *), which means that depending upon the requirements of any organization it can have a program which is presently not being offered to any students.

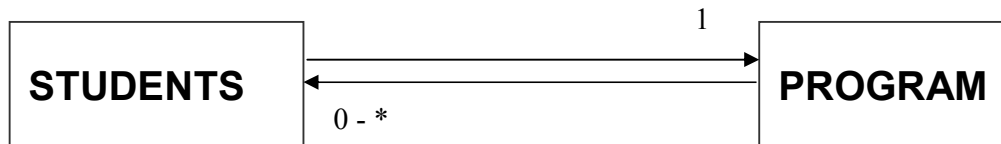

Semester and Course

The relationship in between semester and course is many to many. But it is essential to know the course offered during any particular semester so there is a requirement of an attribute, which is of relationship and when it is many to many it, can also serve as entity which is represented by a diamond in a rectangle. So here this can be a courses offered attribute, which would also be an entity. The primary key of semester that is semester code and primary key of course that is course code, after combining it becomes composite key which would be used to identify any particular course.

Course Offered and Teacher

There is a relationship in between course offered and teacher. The cardinality of course offered and teacher is one that is a teacher can only have one course at a time. Similarly the cardinality in between teacher and course offered is one to many, which means that a teacher can teach many courses.

Student and Course Offered

The relationship in between student and course offered is many to many so this relationship is also through enrolled attribute, which can also serve as entity type. The primary keys of semester, course and student are used as composite key to identify, that which student has got which course.

Semester and Student

To find out GPA of any student the semester is also required to be known. So the relationship in between these two can be through result whose attribute GPA can be used. There is a many to many relationship in these two entities.

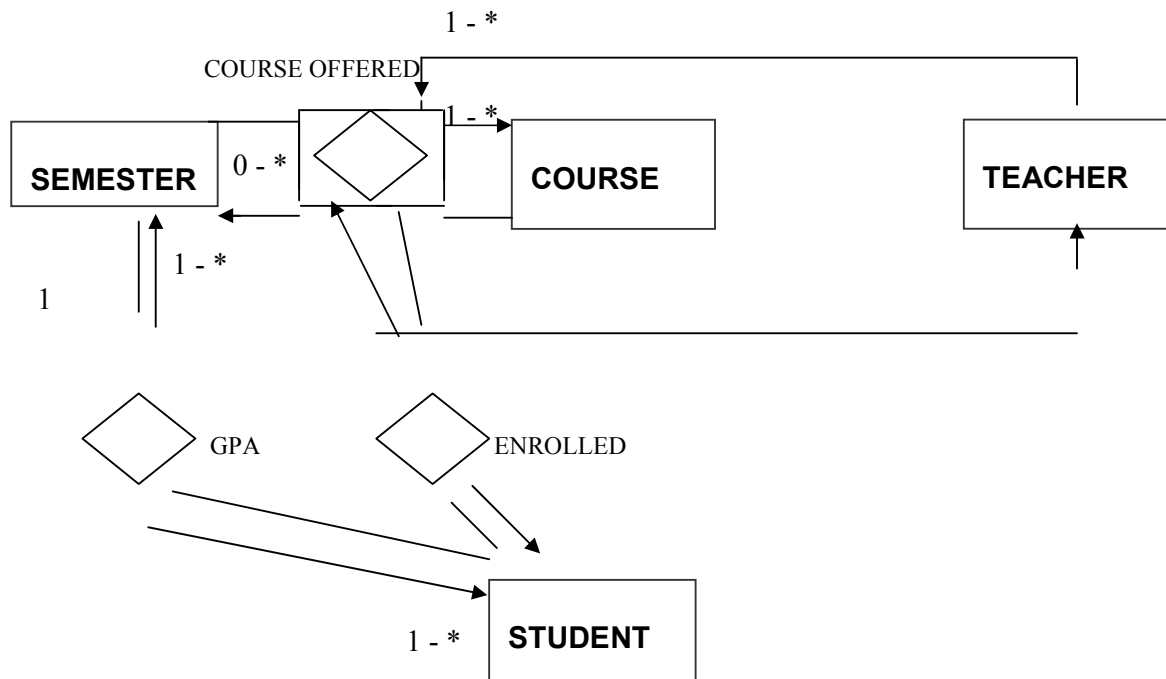

Conceptual Database Design

The outcome of analysis phase is the conceptual database design, which is drawn through E-R model. This design is independent of any tool or data model. This design can be implemented in multiple data models like network, relational or hierarchal models.

Logical Database Design

This is the next phase of database design, in which appropriate data model is chosen, and from here onwards it becomes tool dependent. We will select relational data model and our further lectures will be concerning relational data models

Conclusion

The E – R Model of Examination system of an educational institute discussed above is just a guideline. There can certainly be changes in this model depending upon the requirements of the organization and the outputs required. After drawing an E-R model, all the outputs, which are required, must be matched with the system. If it does not fulfill all the requirements then whole process must be rehashed once again. All necessary modifications and changes must be made before going ahead. For Example, if in this system attendance sheet of the students is required then program code, semester and course codes are required, this composite key will give the desired attendance sheet of the students.

Lecture No. 14

Reading Material

“Database Systems Principles, Design and Implementation” written by Catherine Ricardo, Maxwell Macmillan.	Section 6.1 – 6.3.3
“Database Management Systems”, 2 nd edition, Raghu Ramakrishnan, Johannes Gehrke, McGraw-Hill	

Overview of Lecture

- Logical Database Design
- Introduction to Relational Data Model
- Basic properties of a table
- Mathematical and database relations

From this lecture we are going to discuss the logical database design phase of database development process. Logical database design, like conceptual database design is our database design; it represents the structure of data that we need to store to fulfill the requirements of the users or organization for which we are developing the system. However there are certain differences between the two that are presented in the table below:

	Conceptual Database Design	Logical Database Design
1	Developed in a semantic data model (generally E-R data model)	In legacy data models (relational generally in current age)
2	Free of data model in which going to be implemented; many/any possible	Free of particular DBMS in which going to be implemented; many/any possible
3	Results from Analysis Phase	Obtained by translating the conceptual database design into another data model

4	Represented graphically	Descriptive
5	More expressive	Relatively less expressive
6	Going to be transformed and then implemented	Going to be implemented
You can think more, give a try		

Table 1: Differences between Conceptual and Logical Database Designs

As we have already discussed in previous lectures and as is given in row 2 of the above table, the conceptual database design can be transformed into any data model, like, hierarchical, network, relational or object-oriented. So the study of the logical database design requires first involves the study of the data model/(s) that we can possibly use for the purpose. However, in the current age, since early eighties, the most popular choice for the logical database design is the relational data model; so much popular that today it can be considered to be the only choice. Why? Because of its features we are going to discuss in today's lecture. That is why rather than studying different data models we will be studying only the relational data model. Once we study this, the development of logical database design is transformation of conceptual database design to relational one and the process is very simple and straightforward. So from today's lecture our discussion starts on the relational data model. Just for the sake of revision we repeat the definition of data model "a set of constructs/tools used to develop a database design; generally consists of three components which are constructs, manipulation language and integrity constraints". We have discussed it earlier that the later part of the definition (three components) fits precisely with the relational data model (RDM), that is, it has these components defined clearly.

Relational Data Model

The RDM is popular due to its two major strengths and they are:

- Simplicity
- Strong Mathematical Foundation

The RDM is simple, why, there is just one structure and that is a relation or a table. Even this single structure is very easy to understand, so a user of even of a moderate

genius can understand it easily. Secondly, it has a strong mathematical foundation that gives many advantages, like:

- Anything included/defined in RDM has got a precise meaning since it is based on mathematics, so there is no confusion.
- If we want to test something regarding RDM we can test it mathematically, if it works mathematically it will work with RDM (apart from some exceptions).
- The mathematics not only provided the RDM the structure (relation) but also well defined manipulation languages (relational algebra and relational calculus).
- It provided RDM certain boundaries, so any modification or addition we want to make in RDM, we have to see if it complies with the relational mathematics or not. We cannot afford to cross these boundaries since we will be losing the huge advantages provided by the mathematical backup.

“An IBM scientist E.F. Codd proposed the relational data model in 1970. At that time most database systems were based on one of two older data models (the hierarchical model and the network model); the relational model revolutionized the database field and largely replaced these earlier models. Prototype relational database management systems were developed in pioneering research projects at IBM and UC-Berkeley by the mid-70s, and several vendors were offering relational database products shortly thereafter. Today, the relational model is by far the dominant data model and is the foundation for the leading DBMS products, including IBM's DB2 family, Informix, Oracle, Sybase, Microsoft's Access and SQLServer, FoxBase, and Paradox. Relational database systems are ubiquitous in the marketplace and represent a multibillion dollar industry” [1]

The RDM is mainly used for designing/defining external and conceptual schemas; however to some extent physical schema is also specified in it. Separation of conceptual and physical levels makes data and schema manipulation much easier, contrary to previous data models. So the relational data model also truly supports “Three Level Schema Architecture”.

Introduction to the Relational Data model

The RDM is based on a single structure and that is a relation. Speaking in terms of the E-R data model, both the entity types and relationships are represented using relations

in RDM. The relation in RDM is similar to the mathematical relation however database relation is also represented in a two dimensional structure called table. A table consists of rows and columns. Rows of a table are also called tuples. A row or tuple of a table represents a record or an entity instance, where as the columns of the table represent the properties or attributes.

stID	stName	clName	doB	sex
S001	M. Suhail	MCS	12/6/84	M
S002	M. Shahid	BCS	3/9/86	M
S003	Naila S.	MCS	7/8/85	F
S004	Rubab A.	MBA	23/4/86	F
S005	Ehsan M.	BBA	22/7/88	M

Table 2: A database relation represented in the form of a table

In the above diagram, a table is shown that consists of five rows and five columns. The top most rows contain the names of the columns or attributes whereas the rows represent the records or entity instances. There are six basic properties of the database relations which are:

- Each cell of a table contains atomic/single value

A cell is the intersection of a row and a column, so it represents a value of an attribute in a particular row. The property means that the value stored in a single cell is considered as a single value. In real life we see many situations when a property/attribute of any entity contains multiple values, like, degrees that a person has, hobbies of a student, the cars owned by a person, the jobs of an employee. All these attributes have multiple values; these values cannot be placed as the value of a single attribute or in a cell of the table. It does not mean that the RDM cannot handle such situations, however, there are some special means that we have to adopt in these situations, and they can not be placed as the value of an attribute because an attribute can contain only a single value. The values of attributes shown in table 1 are all atomic or single.

- Each column has a distinct name; the name of the attribute it represents

Each column has a heading that is basically the name of the attribute that the column represents. It has to be unique, that is, a table cannot have duplicated column/attribute names. In the table 2 above, the bold items in the first row represent the column/attribute names.

- The values of the attributes come from the same domain

Each attribute is assigned a domain along with the name when it is defined. The domain represents the set of possible values that an attribute can have. Once the domain has been assigned to an attribute, then all the rows that are added into the table will have the values from the same domain for that particular column. For example, in the table 2 shown above the attribute doB (date of birth) is assigned the domain “Date”, now all the rows have the date value against the attribute doB. This attribute cannot have a text or numeric value.

- The order of the columns is immaterial

If the order of the columns in a table is changed, the table still remains the same. Order of the columns does not matter.

- The order of the rows is immaterial

As with the columns, if rows’ order is changed the table remains the same.

- Each row/tuple/record is distinct, no two rows can be same

Two rows of a table cannot be same. The value of even a single attribute has to be different that makes the entire row distinct.

There are three components of the RDM, which are, construct (relation), manipulation language (SQL) and integrity constraints (two). We have discussed the relation so far; the last two components will be discussed later. In the next section we are going to

discuss the mathematical relations briefly that will help to link the mathematical relations with the database relations and will help in a better understanding of the later.

Mathematical Relations

Consider two sets

$$A = \{x, y\} \quad B = \{2, 4, 6\}$$

Cartesian product of these sets ($A \times B$) is a set that consists of ordered pairs where first element of the ordered pair belongs to set A where as second element belongs to set B, as shown below:

$$A \times B = \{(x,2), (x,4), (x,6), (y,2), (y,4), (y,6)\}$$

A relation is some subset of this Cartesian product, For example,

- $R1 = \{(x,2), (y,2), (x,6), (x,4)\}$
- $R2 = \{(x,4), (y,6), (y,4)\}$

The same notion of Cartesian product and relations can be applied to more than two sets, e.g. in case of three sets, we will have a relation of ordered triplets

Applying the same concept in a real world scenario, consider two sets Name and Age having the elements:

- Name = {Ali, Sana, Ahmed, Sara}
- Age = {15,16,17,18,.....,25}

Cartesian product of Name & Age

$$\text{Name} \times \text{Age} = \{(Ali,15), (Sana,15), (Ahmed,15), (Sara,15), \dots, (Ahmed,25), (Sara,25)\}$$

Now consider a subset CLASS of this Cartesian product

$$\text{CLASS} = \{(Ali, 18), (Sana, 17), (Ali, 20), (Ahmed, 19)\}$$

This subset CLASS is a relation mathematically, however, it may represent a class in the real world where each ordered pair represents a particular student mentioning the name and age of a student. In the database context each ordered pair represents a tuple and elements in the ordered pairs represent values of the attributes. Think in this way, if Name and Age represent all possible values for names and ages of students, then any class you consider that will definitely be a subset of the Cartesian product of the Name and Age. That is, the name and age combination of all the students of any class

will be included in the Cartesian product and if we take out particulars ordered pairs that are related to a class then that will be a subset of the Cartesian product, a relation.

Database Relations

Let $A_1, A_2, A_3, \dots, A_n$ be some attributes and $D_1, D_2, D_3, \dots, D_n$ be their domains. A relation scheme relates certain attributes with their domain in context of a relation. A relation scheme can be represented as:

$R = (A_1:D_1, A_2:D_2, \dots, A_n:D_n)$, for example,

STD Scheme = (stId:Text, stName: Text, stAdres:Text, doB:Date) OR

STD(stId, stName, stAdres, doB)

Whereas the stId, stName, stAdres and doB are the attribute names and Text, Text, Text and Date are their respective domains. A database relation as per this relation scheme can be:

STD = {(stId:S001, stName:Ali, stAdres: Lahore, doB:12/12/76), (stId:S003, stName:A. Rehman, stAdres: RWP, doB:2/12/77)} OR

STD = {(S001, Ali, Lahore, 12/12/76), (S003, A. Rehman, RWP, 2/12/77)}

The above relation if represented in a two dimensional structure will be called a table as is shown below:

stId	stName	stAdres	doB
S001	Ali	Lahore	12/12/76
S002	A. Rehman	RWP	2/12/77

With this, today's lecture is finished; the discussion on RDM will be continued in the next lecture.

Summary

In this lecture we have started the discussion on the logical database design that we develop from the conceptual database design. The later is generally developed using E-R data model, whereas for the former RDM is used. RDM is based on the theory of mathematical relations; a mathematical relation is subset of the Cartesian product of two or more sets. Relations are physically represented in the form of two-dimensional

structure called table, where rows/tuples represent records and columns represent the attributes.

Exercise:

Define different attributes (assigning name and domain to each) for an entity STUDENT, then apply the concept of Cartesian product on the domains of these attributes, then consider the records of your class fellows and see if it is the subset of the Cartesian product.

Lecture No. 15

Reading Material

--	--

Overview of Lecture

- Database and Math Relations
- Degree and Cardinality of Relation
- Integrity Constraints
- Transforming conceptual database design into logical database design
- Composite and multi-valued Attributes
- Identifier Dependency

In the previous lecture we discussed relational data model, its components and properties of a table. We also discussed mathematical and database relations. Now we will discuss the difference in between database and mathematical relations.

Database and Math Relations

We studied six basic properties of tables or database relations. If we compare these properties with those of mathematical relations then we find out that properties of both are the same except the one related to order of the columns. The order of columns in mathematical relations does matter, whereas in database relations it does not matter. There will not be any change in either math or database relations if we change the rows or tuples of any relation. It means that the only difference in between these two is of order of columns or attributes. A math relation is a Cartesian product of two sets. So if we change the order of these two sets then the outcome of both will not be same. Therefore, the math relation changes by changing the order of columns. For Example , if there is a set A and a set B if we take Cartesian product of A and B then we take Cartesian product of B and A they will not be equal , so

$$A \times B \neq B \times A$$

Rests of the properties between them are same.

Degree of a Relation

We will now discuss the degree of a relation not to be confused with the degree of a relationship. You would be definitely remembering that the relationship is a link or association between one or more entity types and we discussed it in E-R data model. However the degree of a relation is the number of columns in that relation. For Example consider the table given below:

STUDENT

stID	stName	clName	Sex
S001	Suhail	MCS	M
S002	Shahid	BCS	M
S003	Naila	MCS	F
S004	Rubab	MBA	F
S005	Ehsan	BBA	M

Table 1: The STUDENT table

Now in this example the relation STUDENT has four columns, so this relation has degree four.

Cardinality of a Relation

The number of rows present in a relation is called as cardinality of that relation. For example, in STUDENT table above, the number of rows is five, so the cardinality of the relation is five.

Relation Keys

The concept of key and all different types of keys is applicable to relations as well. We will now discuss the concept of foreign key in detail, which will be used quite frequently in the RDM.

Foreign Key

An attribute of a table B that is primary key in another table A is called as foreign key. For Example, consider the following two tables EMP and DEPT:

EMP (empId, empName, qual, depId)

DEPT (depId, depName, numEmp)

In this example there are two relations; EMP is having record of employees, whereas DEPT is having record of different departments of an organization. Now in EMP the primary key is empId, whereas in DEPT the primary key is depId. The depId which is primary key of DEPT is also present in EMP so this is a foreign key.

Requirements/Constraints of Foreign Key

Following are some requirements / constraints of foreign key:

There can be more than zero, one or multiple foreign keys in a table, depending on how many tables a particular table is related with. For example in the above example the EMP table is related with the DEPT table, so there is one foreign key depId,

whereas DEPT table does not contain any foreign key. Similarly, the EMP table may also be linked with DESIG table storing designations, in that case EMP will have another foreign key and alike.

The foreign key attribute, which is present as a primary key in another relation is called as home relation of foreign key attribute, so in EMP table the deptId is foreign key and its home relation is DEPT.

The foreign key attribute and the one present in another relation as primary key can have different names, but both must have same domains. In DEPT, EMP example, both the PK and FK have the same name; they could have been different, it would not have made any difference however they must have the same domain.

The primary key is represented by underlining with a solid line, whereas foreign key is underlined by dashed or dotted line.

Primary Key : _____

Foreign Key : - - - - -

Integrity Constraints

Integrity constraints are very important and they play a vital role in relational data model. They are one of the three components of relational data model. These constraints are basic form of constraints, so basic that they are a part of the data model, due to this fact every DBMS that is based on the RDM must support them.

Entity Integrity Constraint:

It states that in a relation no attribute of a primary key (PK) can have null value. If a PK consists of single attribute, this constraint obviously applies on this attribute, so it cannot have the Null value. However, if a PK consists of multiple attributes, then none of the attributes of this PK can have the Null value in any of the instances.

Referential Integrity Constraint:

This constraint is applied to foreign keys. Foreign key is an attribute or attribute combination of a relation that is the primary key of another relation. This constraint states that if a foreign key exists in a relation, either the foreign key value must match the primary key value of some tuple in its home relation or the foreign key value must be completely null.

Significance of Constraints:

By definition a PK is a minimal identifier that is used to identify tuples uniquely. This means that no subset of the primary key is sufficient to provide unique identification of tuples. If we were to allow a null value for any part of the primary key, we would be demonstrating that not all of the attributes are needed to distinguish between tuples, which would contradict the definition.

Referential integrity constraint plays a vital role in maintaining the correctness, validity or integrity of the database. This means that when we have to ensure the proper enforcement of the referential integrity constraint to ensure the consistency and correctness of database. How? In the DEPT, EMP example above deptId in EMP is foreign key; this is being used as a link between the two tables. Now in every instance of EMP table the attribute deptId will have a value, this value will be used to get the name and other details of the department in which a particular employee works. If the value of deptId in EMP is Null in a row or tuple, it means this particular row is not related with any instance of the DEPT. From real-world scenario it means that this particular employee (whose is being represented by this row/tuple) has not been

assigned any department or his/her department has not been specified. These were two possible conditions that are being reflected by a legal value or Null value of the foreign key attribute. Now consider the situation when referential integrity constraints is being violated, that is, EMP.deptId contains a value that does not match with any of the value of DEPT.deptId. In this situation, if we want to know the department of an employee, then oops, there is no department with this Id, that means, an employee has been assigned a department that does not exist in the organization or an illegal department. A wrong situation, not wanted. This is the significance of the integrity constraints.

Null Constraints:

A Null value of an attribute means that the value of attribute is not yet given, not defined yet. It can be assigned or defined later however. Through Null constraint we can monitor whether an attribute can have Null value or not. This is important and we have to make careful use of this constraint. This constraint is included in the definition of a table (or an attribute more precisely). By default a non-key attribute can have Null value, however, if we declare an attribute as Not Null, then this attribute must be assigned value while entering a record/tuple into the table containing that attribute. The question is, how do we apply or when do we apply this constraint, or why and when, on what basis we declare an attribute Null or Not Null. The answer is, from the system for which we are developing the database; it is generally an organizational constraint. For example, in a bank, a potential customer has to fill in a form that may comprise of many entries, but some of them would be necessary to fill in, like, the residential address, or the national Id card number. There may be some entries that may be optional, like fax number. When defining a database system for such a bank, if we create a CLIENT table then we will declare the must attributes as Not Null, so that a record cannot be successfully entered into the table until at least those attributes are not specified.

Default Value:

This constraint means that if we do not give any value to any particular attribute, it will be given a certain (default) value. This constraint is generally used for the efficiency purpose in the data entry process. Sometimes an attribute has a certain value that is assigned to it in most of the cases. For example, while entering data for the students, one attribute holds the current semester of the student. The value of this attribute is changed as a student passes through different exams or semesters during its degree. However, when a student is registered for the first time, it is generally registered in the first semesters. So in the new records the value of current semester attribute is generally 1. Rather than expecting the person entering the data to enter 1 in every record, we can place a default value of 1 for this attribute. So the person can simply skip the attribute and the attribute will automatically assume its default value.

Domain Constraint:

This is an essential constraint that is applied on every attribute, that is, every attribute has got a domain. Domain means the possible set of values that an attribute can have. For example, some attributes may have numeric values, like salary, age, marks etc. Some attributes may possess text or character values, like, name and address. Yet some others may have the date type value, like date of birth, joining date. Domain specification limits an attribute the nature of values that it can have. Domain is specified by associating a data type to an attribute while defining it. Exact data type name or specification depends on the particular tool that is being used. Domain helps

to maintain the integrity of the data by allowing only legal type of values to an attribute. For example, if the age attribute has been assigned a numeric data type then it will not be possible to assign a text or date value to it. As a database designer, this is your job to assign an appropriate data type to an attribute. Another perspective that needs to be considered is that the value assigned to attributes should be stored efficiently. That is, domain should not allocate unnecessary large space for the attribute. For example, age has to be numeric, but then there are different types of numeric data types supported by different tools that permit different range of values and hence require different storage space. Some of more frequently supported numeric data types include Byte, Integer, and Long Integer. Each of these types supports different range of numeric values and takes 1, 4 or 8 bytes to store. Now, if we declare the age attribute as Long Integer, it will definitely serve the purpose, but we will be allocating unnecessarily large space for each attribute. A Byte type would have been sufficient for this purpose since you won't find students or employees of age more than 255, the upper limit supported by Byte data type. Rather we can further restrict the domain of an attribute by applying a check constraint on the attribute. For example, the age attribute although assigned type Byte, still if a person by mistake enters the age of a student as 200, if this is year then it is not a legal age from today's age, yet it is legal from the domain constraint perspective. So we can limit the range supported by a domain by applying the check constraint by limiting it up to say 30 or 40, whatever is the rule of the organization. At the same time, don't be too sensitive about storage efficiency, since attribute domains should be large enough to cater the future enhancement in the possible set of values. So domain should be a bit larger than that is required today. In short, domain is also a very useful constraint and we should use it carefully as per the situation and requirements in the organization.

RDM Components

We have up till now studied following two components of the RDM, which are the Structure and Entity Integrity Constraints. The third part, that is, the Manipulation Language will be discussed in length in the coming lectures.

Designing Logical Database

Logical data base design is obtained from conceptual database design. We have seen that initially we studied the whole system through different means. Then we identified different entities, their attributes and relationship in between them. Then with the help of E-R data model we achieved an E-R diagram through different tools available in this model. This model is semantically rich. This is our conceptual database design. Then as we had to use relational data model so then we came to implementation phase for designing logical database through relational data model.

The process of converting conceptual database into logical database involves transformation of E-R data model into relational data model. We have studied both the data models, now we will see how to perform this transformation.

Transforming Rules

Following are the transforming rules for converting conceptual database into logical database design:

The rules are straightforward, which means that we just have to follow the rules mentioned and the required logical database design would be achieved

There are two ways of transforming first one is manually that is we analyze and evaluate and then transform. Second is that we have CASE tools available with us which can automatically convert conceptual database into required logical database design

If we are using CASE tools for transforming then we must evaluate it as there are multiple options available and we must make necessary changes if required.

Mapping Entity Types

Following are the rules for mapping entity types:

Each regular entity type (ET) is transformed straightaway into a relation. It means that whatever entities we had identified they would simply be converted into a relation and will have the same name of relation as kept earlier.

Primary key of the entity is declared as Primary key of relation and underlined.

Simple attributes of ET are included into the relation

For Example, figure 1 below shows the conversion of a strong entity type into equivalent relation:

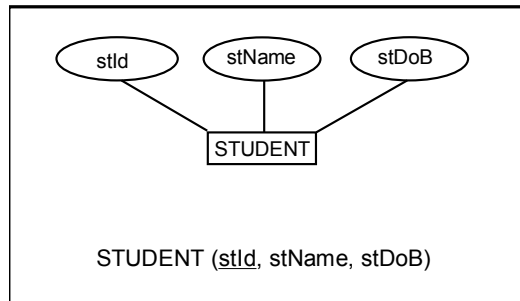

Fig. 1: An example strong entity type

Composite Attributes

These are those attributes which are a combination of two or more than two attributes. For address can be a composite attribute as it can have house no, street no, city code and country, similarly name can be a combination of first and last names. Now in relational data model composite attributes are treated differently. Since tables can contain only atomic values composite attributes need to be represented as a separate relation

For Example in student entity type there is a composite attribute Address, now in E-R model it can be represented with simple attributes but here in relational data model, there is a requirement of another relation like following:

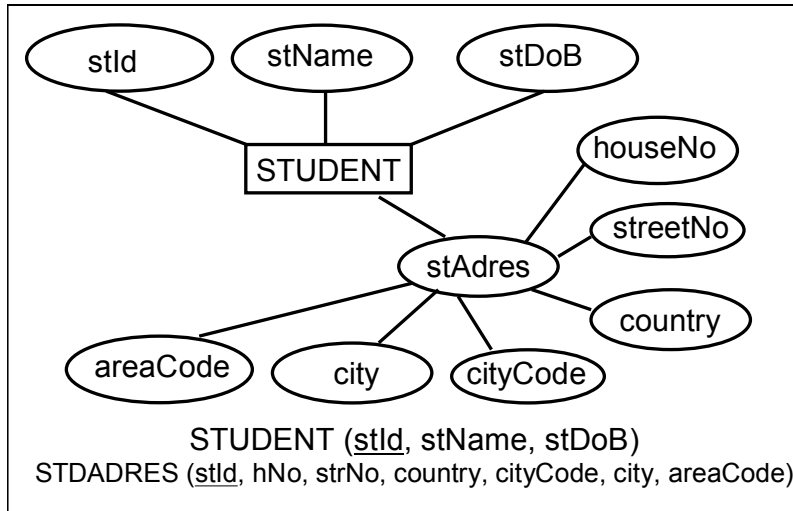

Fig. 2: Transformation of composite attribute

Figure 2 above presents an example of transforming a composite attribute into RDM, where it is transformed into a table that is linked with the STUDENT table with the primary key

Multi-valued Attributes

These are those attributes which can have more than one value against an attribute. For Example a student can have more than one hobby like riding, reading listening to music etc. So these attributes are treated differently in relational data model.

Following are the rules for multi-valued attributes:-

An Entity type with a multi-valued attribute is transformed into two relations. One contains the entity type and other simple attributes whereas the second one has the multi-valued attribute. In this way only single atomic value is stored against every attribute.

The Primary key of the second relation is the primary key of first relation and the attribute value itself. So in the second relation the primary key is the combination of two attributes.

